

REPUBLIC OF KENYA



**MINISTRY OF AGRICULTURE AND LIVESTOCK DEVELOPMENT
STATE DEPARTMENT FOR CROP DEVELOPMENT AND AGRICULTURE**

SMALL SCALE IRRIGATION AND VALUE ADDITION PROJECT

Tender No. MOALD/SIVAP/T040/2023-2024

**DRILLING AND EQUIPPING OF KISEUNI COMMUNITY
BOREHOLE IN MACHAKOS COUNTY**

National Competitive Bidding
Instruction to bids, conditions of contract, Specifications &
Bills of Quantities

Launched: 8th August, 2023

Closing: 5th September, 2023

Name of Bidder:

SPECIFIC PROCUREMENT NOTICE



REPUBLIC OF KENYA

MINISTRY OF AGRICULTURE AND LIVESTOCK

STATE DEPARTMENT FOR CROP DEVELOPMENT

SMALL SCALE IRRIGATION AND VALUE ADDITION PROJECT (SIVAP)

ADVERTISEMENT

Date: **8th August, 2023**

Loan No: **2000130014530**

Project ID No.: **P-KE-AAZ-009**

DRILLING AND EQUIPPING OF KISEUNI COMMUNITY BOREHOLE IN MACHAKOS COUNTY.

1. This Invitation for Bids follows the General Procurement Notice (GPN) for this project that appeared in UNDB online **AfDB811-11/15 of 19th November, 2015** and on the African Development Bank Group's Internet Website.
2. The Government of Kenya has received a loan from the African Development Bank towards the cost of the **Small-Scale Irrigation and Value Addition Project (SIVAP)**. It is intended that part of the Proceeds of this loan will be applied to eligible payments under the contract for Drilling and Equipping of Kiseuni Community Borehole in Machakos County.
3. The Ministry of Agriculture and Livestock Development now invites sealed bids from eligible bidders for the above works as below;

S/NO	TENDER NUMBER	TENDER DESCRIPTION	BID SECURITY (KES)
1.	MOALD/SIVAP/T001/2023-2024	Drilling and Equipping of Gaterono 1 Borehole in Meru County	310,000.00
2.	MOALD/SIVAP/T002/2023-2024	Drilling and Equipping of Gaterone 2 Borehole in Meru County	310,000.00

3.	MOALD/SIVAP/T003/2023-2024	Drilling and Equipping of Rutendene Borehole in Meru County	310,000.00
4.	MOALD/SIVAP/T004/2023-2024	Drilling and Equipping of Mwero Muthanga Borehole in Meru County	310,000.00
5.	MOALD/SIVAP/T005/2023-2024	Drilling And Equipping of Mabacha Borehole in Meru County	310,000.00
6.	MOALD/SIVAP/T006/2023-2024	Drilling and Equipping of Lothera Borehole in Meru County	310,000.00
7.	MOALD/SIVAP/T007/2023-2024	Drilling and Equipping of Ntugu 'A' (Mwangathia) Community Water Supply	310,000.00
8.	MOALD/SIVAP/T008/2023-2024	Drilling and Equipping of Nairuru Primary School (Antubetwe Kiongo)	310,000.00
9.	MOALD/SIVAP/T009/2023-2024	Drilling and Equipping of Achoro Kiluencene Borehole in Meru County	310,000.00
10.	MOALD/SIVAP/T010/2023-2024	Drilling and Equipping Kanatha Primary School Borehole in Meru County	310,000.00
11.	MOALD/SIVAP/T011/2023-2024	Drilling and Equipping of Majarene Potato Aggregation Centre Borehole in Meru County	310,000.00
12.	MOALD/SIVAP/T012/2023-2024	Drilling and Equipping of Kithima Borehole in Meru County	310,000.00
13.	MOALD/SIVAP/T013/2023-2024	Drilling and Equipping of Mituguuru Borehole in Meru County	310,000.00
14.	MOALD/SIVAP/T014/2023-2024	Drilling and Equipping of Majengo Borehole in Meru County	310,000.00
15.	MOALD/SIVAP/T015/2023-2024	Drilling and Equipping of Ngundune Livestock Sale Yard Borehole in Meru County	310,000.00
16.	MOALD/SIVAP/T016/2023-2024	Drilling and Equipping of Muthara Grading Marketing Shed Borehole in Meru County	290,000.00

17.	MOALD/SIVAP/T017/2023-2024	Drilling and Equipping of Mituntu (Kianjai) Community Borehole in Meru County	300,000.00
18.	MOALD/SIVAP/T018/2023-2024	Drilling and Equipping of Kamiti- 1 Borehole in Meru County	310,000.00
19.	MOALD/SIVAP/T019/2023-2024	Drilling And Equipping of Nkiene Primary School Borehole in Meru County	310,000.00
20.	MOALD/SIVAP/T020/2023-2024	Drilling and Equipping of Mumone Primary School Borehole in Meru County	310,000.00
21.	MOALD/SIVAP/T021/2023-2024	Drilling and Equipping of Gitine (Igoji) Community Water Project (Secondary School in Meru County	310,000.00
22.	MOALD/SIVAP/T022/2023-2024	Drilling and Equipping of Thubai Primary School Borehole in Meru County	310,000.00
23.	MOALD/SIVAP/T023/2023-2024	Drilling and Equipping of St. Mary's Primary School Borehole in Meru County	310,000.00
24.	MOALD/SIVAP/T024/2023-2024	Drilling and Equipping of Malaene Primary School Borehole in Meru County	310,000.00
25.	MOALD/SIVAP/T025/2023-2024	Drilling and Equipping of Kalonga Primary School Borehole in Kitui County	260,000.00
26.	MOALD/SIVAP/T026/2023-2024	Drilling and Equipping of Mavuni Primary School Borehole in Kitui County	260,000.00
27.	MOALD/SIVAP/T027/2023-2024	Drilling and Equipping of Matiiia Area Borehole in Kitui County	260,000.00
28.	MOALD/SIVAP/T028/2023-2024	Drilling and Equipping of Mang'elu Primary School Borehole in Kitui County	260,000.00
29.	MOALD/SIVAP/T029/2023-2024	Drilling and Equipping of Ivulyamuu Primary School Borehole in Kitui County	260,000.00
30.	MOALD/SIVAP/T030/2023-2024	Drilling and Equipping of Mang'ola Community Borehole in Kitui County	260,000.00

31.	MOALD/SIVAP/T031/2023-2024	Construction of Ngundune Livestock Sale Yard in Meru County	270,000.00
32.	MOALD/SIVAP/T032/2023-2024	Construction of Mwangeni Livestock Sale Yard in Kitui County	270,000.00
33.	MOALD/SIVAP/T033/2023-2024	Construction of Maua Marketing Shed in Meru County	880,000.00
34.	MOALD/SIVAP/T034/2023-2024	Construction Buuri IWUA Office in Meru County	100,000.00
35.	MOALD/SIVAP/T035/2023-2024	Construction of Muthara Marketing Shed Sanitary Facilities in Meru County	80,000.00
36.	MOALD/SIVAP/T036/2023-2024	Construction of Kirumi Kiamunjari Irrigation Scheme Grading and Marketing Shed in Tharak Nihi County	290,000.00
37.	MOALD/SIVAP/T037/2023-2024	Construction of Meko Ma Kongoa Grading and Marketing Shed in Kitui County	290,000.00
38.	MOALD/SIVAP/TO38/2023-2024	Spot Improvement of 12 Km of Roads in Kitui County	400,000.00
39.	MOALD/SIVAP/T039/2023-2024	Spot Improvement of 18.8 Km Roads in Kisima in Meru County	450,000.00
40.	MOALD/SIVAP/T040/2023-2024	Drilling and Equipping of Kiseuni Community Borehole in Machakos County	240,000.00
41.	MOALD/SIVAP/T041/2023-2024	Construction of Murang'a Livestock Sale Yard in Murang'a County	290,000.00
42.	MOALD/SIVAP/T042/2023-2024	Drilling and Equipping of Gikindu Grading/Marketing Borehole in Murang'a County	260,000.00
43.	MOALD/SIVAP/T043/2023-2024	Drilling and Equipping of Utangwa Grading/Marketing Shed Borehole in Makueni County	240,000.00

44.	MOALD/SIVAP/T044/2023-2024	Drilling and Equipping of Kiuwini Borehole in Machakos County	240,000.00
45.	MOALD/SIVAP/T045/2023-2024	Drilling and Equipping of Kwasuvu Primary School Borehole in Machakos County	240,000.00
46.	MOALD/SIVAP/T046/2023-2024	Drilling and Equipping of Kyondoni Primary School Borehole in Machakos County	240,000.00
47.	MOALD/SIVAP/T047/2023-2024	Construction of Karindundu Livestock Sale Yard in Nyeri County	270,000.00
48.	MOALD/SIVAP/T048/2023-2024	Re- Advertisement Construction of Ndiriti Aguthi Marketing and Grading Shed in Nyeri County	120,000.00
49.	MOALD/SIVAP/T049/2023-2024	Drilling and Equipping of Galilee Community Borehole in Makueni County	240,000.00
50.	MOALD/SIVAP/T050/2023-2024	Re- Advertisement of Kako linga Community Borehole in Makueni County	240,000.00
51.	MOALD/SIVAP/T051/2023-2024	Re- Advertisement of Construction of Kathwana Livestock Market in Tharaka Nithi County	270,000.00
52.	MOALD/SIVAP/T052/2023-2024	Drilling and Equipping of Kalanzoni Community Borehole in Makueni County	240,000.00
53.	MOALD/SIVAP/T053/2023-2024	Drilling and Equipping of Kalamba Village Borehole in Machakos County	240,000.00
54.	MOALD/SIVAP/T054/2023-2024	Re- Advertisement of Drilling and Equipping of Kanyonga Community Borehole in Makueni County	240,000.00
55.	MOALD/SIVAP/T055/2023-2024	Spot Improvement Of 15.1 Km of Roads in Nkomo And Thangatha Ward in Meru County	450,000.00

4. Interested eligible bidders may obtain further information from the Office of the **Project Coordinator, Small-scale Irrigation and Value Addition Project (SIVAP), Hill Plaza 9th Floor, Ngong Road P.O. Box 30028 00100 Nairobi.**
5. A complete set of bidding documents may be **down loaded** from the Ministry's web site www.kilimo.go.ke
6. The provisions in the Instructions to Bidders and in the General Conditions of Contract are the provisions of the **African Development Bank Standard Bidding Document: Procurement of Works.**
7. Bids should be clearly marked 'Drilling and Equipping of Kiseuni Community Borehole in Machakos County, **Tender No. MOALD/SIVAP/T040/2023-2024** and deposited at **State Department for Crop Development Tender Box, situated at the Ground Floor, Kilimo House, Cathedral Road** or posted to:

**Principal Secretary
State Department for Crop Development
Ministry of Agriculture and Livestock Development
Kilimo House, Cathedral Road
P. O. Box 30028-00100
NAIROBI**

and should be received on or before **Tuesday 5th September, 2023 at 11.00 am local time and *MUST* be accompanied by a bid guarantee as indicated in the table above.**

Bulky bid documents that cannot fit in the tender box should be dropped at the Head: Supply Chain Management Office at Kilimo House, 4th Floor Room 4-2B.

8. Bids will be opened in the presence of bidders' representatives who choose to attend at **11.00am on Tuesday 5th September, 2023 at the Conference Room Kilimo House 7th Floor.**

**Head, Supply Chain Management Unit
State Department for Crop Development**

FOR: PRINCIPAL SECRETARY

PART 1 – BIDDING PROCEDURES

Section I. Instructions to Bidders (ITB)

This Section provides relevant information to help Bidders prepare their bids. Information is also provided on the submission, opening, and evaluation of bids and on the award of Contracts.

Section II. Bid Data Sheet (BDS)

This Section consists of provisions that are specific to each procurement and that supplement the information or requirements included in Section I, **Instructions to Bidders**.

Section III. Evaluation and Qualification Criteria

This Section contains the criteria to determine the lowest evaluated bid and the qualifications of the Bidder to perform the contract.

Section IV. Bidding Forms

This Section contains the forms which are to be completed by the Bidder and submitted as part of his Bid

Section V. Eligible Countries

This Section contains information regarding eligible countries.

PART 2 – EMPLOYER’S REQUIREMENTS

Section VI. Requirements

This Section contains the Specification, the Drawings, and supplementary information that describe the Works to be procured.

PART 3 – CONDITIONS OF CONTRACT AND CONTRACT FORMS

Section VII. General Conditions (GC)

This Section contains the general clauses to be applied in all contracts.

Section VIII. Particular Conditions (PC)

This Section consists of Contract Data and Specific Provisions which contains clauses specific to each contract. The contents of this Section supplement the General Conditions and shall be prepared by the Employer.

Section IX. Contract Forms

This Section contains forms which, once completed, will form part of the Contract. The forms for **Performance Security** and **Advance Payment Security**, when required, shall only be completed by the successful Bidder after contract award.

Table of Contents

<u>PART 1 – Bidding Procedures</u>	10
<u>Section I. Instructions to Bidders</u>	11
<u>Section II. Bid Data Sheet</u>	34
<u>Section III. Evaluation and Qualification Criteria</u>	38
<u>Section IV. Bidding Forms</u>	49
<u>Section V. Eligible Countries</u>	107
<u>PART 2 – Employer’s Requirements</u>	108
<u>Section VI. Requirements</u>	109
<u>PART 3 – Conditions of Contract and Contract Forms</u>	179
<u>Section VII. General Conditions (GC)</u>	181
<u>Section VIII. Particular Conditions</u>	219
<u>Section IX. Contract Forms</u>	223
PART 1 – Bidding Procedures	

Section I. Instructions to Bidders

Table of Contents

<u>A.</u>	<u>General</u>	13
1.	<u>Scope of Bid</u>	13
2.	<u>Source of Funds</u>	13
3.	<u>Fraud and Corruption</u>	13
4.	<u>Eligible Bidders</u>	15
5.	<u>Eligible Goods and Related Services</u>	18
<u>B.</u>	<u>Contents of Bidding Document</u>	18
6.	<u>Sections of Bidding Document</u>	18
7.	<u>Clarification of Bidding Document, Site Visit, Pre-Bid Meeting</u>	19
8.	<u>Amendment of Bidding Document</u>	20
<u>C.</u>	<u>Preparation of Bids</u>	20
9.	<u>Cost of Bidding</u>	20
10.	<u>Language of Bid</u>	20
11.	<u>Documents Comprising the Bid</u>	20
12.	<u>Letter of Bid and Price Schedules</u>	21
13.	<u>Alternative Bids</u>	21
14.	<u>Bid Prices and Discounts</u>	22
15.	<u>Currencies of Bid and Payment</u>	23
16.	<u>Documents Establishing the Qualifications of the Bidder</u>	23
17.	<u>Documents Establishing the Eligibility of the Goods and Related Services</u>	23
18.	<u>Period of Validity of Bids</u>	23
19.	<u>Bid Security</u>	24
20.	<u>Format and Signing of Bid</u>	25
<u>D.</u>	<u>Submission and Opening of Bids</u>	25
21.	<u>Submission, Sealing and Marking of Bids</u>	26
22.	<u>Deadline for Submission of Bids</u>	26
23.	<u>Late Bids</u>	26
24.	<u>Withdrawal, Substitution, and Modification of Bids</u>	26
25.	<u>Bid Opening</u>	27

<u>E.</u>	<u>Examination of Bids</u>	28
<u>26.</u>	<u>Confidentiality</u>	28
<u>27.</u>	<u>Clarification of Bids</u>	28
<u>28.</u>	<u>Determination of Responsiveness</u>	29
<u>F.</u>	<u>Bid Evaluation and Comparison</u>	30
<u>29.</u>	<u>Correction of Arithmetical Errors</u>	30
<u>30.</u>	<u>Conversion to Single Currency</u>	30
<u>31.</u>	<u>Bid Adjustments</u>	30
<u>32.</u>	<u>Qualification of the Bidder</u>	31
<u>33.</u>	<u>Comparison of Bid</u>	31
<u>34.</u>	<u>Employer’s Right to Accept Any Bid, and to Reject Any or All Bids</u>	31
<u>G.</u>	<u>Award of Contract</u>	31
<u>35.</u>	<u>Award Criteria</u>	31
<u>36.</u>	<u>Notification of Award</u>	32
<u>37.</u>	<u>Signing of Contract</u>	32
<u>38.</u>	<u>Performance Security</u>	33

Section I. Instructions to Bidders

General

- 1. Scope of Bid**
 - 1.1 The Employer indicated in Section II, **Bid Data Sheet (BDS)** issues this Bidding Document for the procurement of Works, as specified in Section VI, Requirements. The name, identification, and number of lots are provided in the **BDS**.
 - 1.2 Unless otherwise stated, throughout this Bidding Document definitions and interpretations shall be as prescribed in Section VII, **General Conditions**.
- 2. Source of Funds**
 - 2.1 The Borrower or Recipient (hereinafter called “Borrower”) indicated in the **BDS** has applied for or received financing (hereinafter called “funds”) from the African Development Bank¹ (hereinafter called “the Bank”) toward the cost of the project named in the **BDS**. The Borrower intends to apply a portion of the funds to eligible payments under the contract(s) for which this Bidding Document is issued.
 - 2.2 Payments by the Bank will be made only at the request of the Borrower and upon approval by the Bank in accordance with the terms and conditions of the financing agreement between the Borrower and the Bank (hereinafter called the Loan Agreement), and will be subject in all respects to the terms and conditions of that Loan Agreement. No party other than the Borrower shall derive any rights from the Loan Agreement or have any claim to the funds.
- 3. Fraud and Corruption**
 - 3.1 It is the Bank’s policy to require that Borrowers (including beneficiaries of Bank Financing), as well as bidders, suppliers, and contractors, and their agents (whether declared or not), subcontractors, sub-consultants, service providers or suppliers, and any personnel thereof, under Bank-financed contracts, observe the highest standard of ethics during the procurement and execution of such contracts². In pursuance of this policy, the Bank:
 - (a) defines, for the purposes of this provision, the terms set forth below as follows:

¹ The specific financing institution shall be as stipulated in the **BDS**.

² *In this context, any action to influence the procurement process or contract execution for undue advantage is improper.*

- (i) “Corrupt Practice” is the offering, giving, receiving, or soliciting, directly or indirectly, of anything of value to influence improperly the actions of another party³;
- (ii) “Fraudulent Practice” any act or omission, including a misrepresentation that knowingly or recklessly misleads, or attempts to mislead, a party to obtain financial or other benefit or to avoid an obligation;
- (iii) “Collusive Practice” is an arrangement between two or more parties⁴, designed to achieve an improper purpose, including to influence improperly the actions of another party; and
- (iv) “Coercive Practice” is impairing or harming, or threatening to impair or harm, directly or indirectly, any party or the property of the party to influence improperly the actions of a party⁵;
- (v) “Obstructive practice” is
 - (v.1) deliberately destroying, falsifying, altering, or concealing of evidence material to the investigation or making false statements to investigators in order to materially impede a Bank investigation into allegations of a corrupt, fraudulent, coercive or collusive practice; and/or threatening, harassing or intimidating any party to prevent it from disclosing its knowledge of matters relevant to the investigation or from pursuing the investigation, or
 - (v.2) acts intended to materially impede the exercise of the Bank’s inspection and audit rights provided for under paragraph 3.1(e) below.
- (b) will reject a proposal for award if it determines that the bidder recommended for award, or any of its personnel, or its agents, or its sub-consultants, sub-contractors, service providers, suppliers and/or their employees has, directly or indirectly, engaged in Corrupt, Fraudulent,

³ For the purpose of this sub-paragraph, “another party” refers to a public official acting in relation to the procurement process or contract execution. In this context, “public official” includes Bank staff and employees of other organizations taking or reviewing procurement decisions.

⁴ For the purpose of this sub-paragraph, “parties” refers to participants in the procurement process (including public officials) attempting either themselves, or through another person or entity not participating in the procurement or selection process, to simulate competition or to establish bid prices at artificial, non-competitive levels, or are privy to each other’s bid prices or other conditions.

⁵ For the purpose of this sub-paragraph, “party” refers to a participant in the procurement process or contract execution.

Collusive, Coercive, or Obstructive Practices in competing for the contract in question;

- (c) will declare misprocurement and cancel the portion of the Financing allocated to a contract if it determines at any time that representatives of the Borrower or of a recipient of any part of the proceeds of such Financing engaged in Corrupt, Fraudulent, Collusive, Coercive or Obstructive Practices during the procurement or the implementation of that contract, without the Borrower having taken timely and appropriate action satisfactory to the Bank to address such practices when they occur, including by failing to inform the Bank in a timely manner at the time they knew of the practices;
- (d) will sanction a firm or individual, at any time, in accordance with the prevailing Bank's sanctions procedures⁶ including by publicly declaring such firm or individual ineligible to bid for, or to be awarded Bank-financed contracts either indefinitely or for a stated period of time, (i) to be awarded a Bank-financed contract; (ii) to be a nominated⁷ sub-contractor, consultant, supplier, or service provider of an otherwise eligible firm being awarded a Bank-financed contract; and
- (e) will require that a clause be included in bidding documents and in contracts financed by the Bank, requiring bidders, suppliers and contractors and their sub-contractors, agents, personnel, consultants, service providers, or suppliers, to permit the Bank to inspect all accounts and records and other documents relating to the submission of bids and contract performance and to have them audited by auditors appointed by the Bank.

3.2 Furthermore, Bidders shall be aware of the provisions stated in Section VII, **General Conditions**.

- 4. Eligible Bidders** 4.1 A Bidder may be a natural person, private entity, government-owned entity—subject to **ITB 4.5**—or any combination of such entities supported by a letter of intent to enter into an agreement or under an existing agreement in the form of a joint venture, consortium, or

⁶ A firm or an individual may be declared ineligible to be awarded a Bank financed contract: (i) upon completion of the Bank's sanctions proceedings as per its sanctions procedures, including, inter alia, cross-debarment as agreed with other International Financial Institutions, including Multilateral Development Banks, or otherwise decided by the Bank; and through the application of the Proposal for the Implementation of a Sanctions Process within the African Development Bank Group; and (ii) as a result of temporary suspension or early temporary suspension in connection with an on-going sanction proceeding. See footnote 18 and paragraph 9 of Appendix 1 of the Rules and Procedures for Procurement of Goods and Works.

⁷ A nominated sub-contractor, consultant, manufacturer or supplier, or service provider (different names are used depending on the particular bidding documents) is one which has either been: (i) included by the bidder in its pre-qualification application or bid because it brings specific and critical experience and know-how that allow the bidder to meet the qualification requirement for the particular bid; or (ii) appointed by the Borrower. ”

association (JVCA). In the case of a joint venture, consortium, or association:

- (a) unless otherwise specified in the **BDS**, all partners shall be jointly and severally liable, and
- (b) the JVCA shall nominate a Representative who shall have the authority to conduct all businesses for and on behalf of any and all the partners of the JVCA during the bidding process and, in the event the JVCA is awarded the Contract, during contract execution.

4.2 A Bidder, and all parties constituting the Bidder, shall have the nationality of an eligible country, in accordance with the Bank's **Rules and Procedures for Procurement of Goods and Works**, and as listed in Section V, Eligible Countries.⁸ A Bidder shall be deemed to have the nationality of a country if the Bidder is a citizen or is constituted, incorporated, or registered and operates in conformity with the provisions of the laws of that country. This criterion shall also apply to the determination of the nationality of proposed subcontractors or suppliers for any part of the Contract including Related Services.

4.3 A Bidder shall not have a conflict of interest. All Bidders found to have a conflict of interest shall be disqualified. A Bidder may be considered to have a conflict of interest with one or more parties in this bidding process, if:

- (a) they have controlling partners in common; or
- (b) they receive or have received any direct or indirect subsidy from any of them; or
- (c) they have the same legal representative for purposes of this bid; or
- (d) they have a relationship with each other, directly or through common third parties, that puts them in a position to have access to information about or influence on the bid of another Bidder, or influence the decisions of the Employer regarding this bidding process; or
- (e) a Bidder participates in more than one bid in this bidding process. Participation by a Bidder in more than one Bid will result in the disqualification of all Bids in which it is involved. However, this does not limit the inclusion of the same

⁸ Including eligibility criteria for participation in the supply of goods, works and related services.

- subcontractor, not otherwise participating as a Bidder, in more than one bid; or
- (f) a Bidder participated as a consultant in the preparation of Section VI, Requirements that are the subject of the bid.
 - (g) a Bidder or any of its affiliates has been hired, or is proposed to be hired, by the Employer or the Borrower for the supervision of the contract.
- 4.4 A Bidder that is under a declaration of ineligibility by the Bank in accordance with **ITB** Clause 3, at the date of the deadline for bid submission or thereafter, shall be disqualified.
- 4.5 Government-owned entities in the Borrower's country shall be eligible only if they can establish that they (i) are legally and financially autonomous, (ii) operate under the principles of commercial law, and (iii) are not dependent agencies of the Employer or the Borrower.
- 4.6 Bidders shall not be under execution of a Bid–Securing Declaration in the Employer's Country.
- 4.7 Bidders shall provide such evidence of their continued eligibility satisfactory to the Employer, as the Employer shall reasonably request.
- 4.8 Firms from an eligible country shall be excluded if:
- (a) as a matter of law or official regulation, the Borrower's country prohibits commercial relations with that country; or
 - (b) by an act of compliance with a decision of the United Nations Security Council taken under Chapter VII of the Charter of the United Nations, the Borrower's country prohibits any import of Goods from that country or any payments to persons or entities in that country.
- 4.9 In case a prequalification process has been conducted prior to the bidding process, this bidding is open only to prequalified Bidders.
- 4.10 A firm sanctioned by the Bank in accordance with the above ITB Clause 3.1 (d), or in accordance with the Bank's policies on anti-corruption and fraud and Bank's sanctions procedures⁹, shall be ineligible to be awarded a Bank-financed contract, or to benefit from

⁹ See the Proposal for the Implementation of a Sanctions Process within the African Development Bank Group and the Bank's Whistleblowing and Complaints Handling Policy. The Bank's sanctions procedures are publicly disclosed on the Bank's external website."

a Bank-financed contract, financially or in any other manner, during the period of time determined by the Bank

5. Eligible Goods and Related Services

- 5.1 All Goods and Related Services to be supplied under the Contract and financed by the Bank, shall have as their country of origin an eligible country of the Bank in accordance with the Bank's **Rules and Procedures for Procurement of Goods and Works**, as listed in Section V, Eligible Countries.
- 5.2 For purposes of this Clause, the term "Goods" includes commodities, raw material, machinery, equipment, and industrial plants; and "Related Services" includes services such as insurance, transportation, installation, and commissioning, training, and initial maintenance.
- 5.3 The term "country of origin" means the country where the Goods have been mined, grown, cultivated, produced, manufactured, or processed; or through manufacture, processing, or assembly, another commercially recognized article results that differs substantially in its basic characteristics from its imported components.
- 5.4 The nationality of the firm that produces, assembles, distributes, or sells the Goods shall not determine their origin.

Contents of Bidding Document

6. Sections of Bidding Document

- 6.1 The Bidding Document consist of Parts 1, 2, and 3, which include all the Sections indicated below, and should be read in conjunction with any Addenda issued in accordance with **ITB 8**.

PART 1 Bidding Procedures

- Section I. Instructions to Bidders (**ITB**)
- Section II. Bid Data Sheet (**BDS**)
- Section III. Evaluation and Qualification Criteria
- Section IV. Bidding Forms
- Section V. Eligible Countries

PART 2 Employer's Requirements

- Section VI. Requirements

PART 3 Conditions of Contract and Contract Forms

- Section VII. General Conditions (**GC**)
- Section VIII. Particular Conditions (**PC**)
- Section IX. Contract Forms

-
- 6.2 The Invitation for Bids issued by the Employer is not part of the Bidding Document.
- 6.3 The Bidder shall obtain the Bidding Document from the source stated by the Employer in the Invitation for Bids; otherwise the Employer is not responsible for the completeness of the Bidding Document.
- 6.4 The Bidder is expected to examine all instructions, forms, terms, and specifications in the Bidding Document. Failure to furnish all information or documentation required by the Bidding Document may result in the rejection of the bid.
- 7. Clarification of Bidding Document, Site Visit, Pre-Bid Meeting**
- 7.1 A prospective Bidder requiring any clarification of the Bidding Document shall contact the Employer in writing at the Employer's address indicated in the **BDS** or raise his enquiries during the pre-bid meeting if provided for in accordance with **ITB 7.4**. The Employer will respond to any request for clarification, provided that such request is received prior to the deadline for submission of bids, within the number of days specified in the **BDS**. The Employer response shall be in writing with copies to all Bidders who have acquired the Bidding Document in accordance with **ITB 6.3**, including a description of the inquiry but without identifying its source. Should the Employer deem it necessary to amend the Bidding Document as a result of a request for clarification, it shall do so following the procedure under **ITB 8** and **ITB 22.2**.
- 7.2 Where applicable, the Bidder is advised to visit and examine the project site and obtain for itself on its own responsibility all information that may be necessary for preparing the bid and entering into a contract for the provision of the Requirements. The costs of visiting the site shall be at the Bidder's own expense.
- 7.3 Pursuant to **ITB 7.2**, where the Bidder and any of its personnel or agents have been granted permission by the Employer to enter upon its premises and lands for the purpose of such visit, the Bidder, its personnel, and agents will release and indemnify the Employer and its personnel and agents from and against all liability in respect thereof, and will be responsible for death or personal injury, loss of or damage to property, and any other loss, damage, costs, and expenses incurred as a result of the visit.
- 7.4 The Bidder's designated representative is invited to attend a pre-bid meeting, if provided for in the **BDS**. The purpose of the meeting will be to clarify issues and to answer questions on any matter that may be raised at that stage. If so provided for in the **BDS**, the Employer will organize a site visit.

- 7.5 The Bidder is requested, as far as possible, to submit any questions in writing, to reach the Employer not later than one week before the meeting.
- 7.6 Minutes of the pre-bid meeting, including the text of the questions raised without identifying the source, and the responses given, together with any responses prepared after the meeting, will be transmitted promptly to all Bidders who have acquired the Bidding Document in accordance with **ITB 6.3**. Any modification to the Bidding Document that may become necessary as a result of the pre-bid meeting shall be made by the Employer exclusively through the issue of an Addendum pursuant to **ITB 8** and not through the minutes of the pre-bid meeting.
- 7.7 Non-attendance at the pre-bid meeting will not be a cause for disqualification of a Bidder.
- 8. Amendment of Bidding Document**
- 8.1 At any time prior to the deadline for submission of bids, the Employer may amend the Bidding Document by issuing addenda.
- 8.2 Any addendum issued shall be part of the Bidding Document and shall be communicated in writing to all who have obtained the Bidding Document from the Employer in accordance with **ITB 6.3**.
- 8.3 To give prospective Bidders reasonable time in which to take an addendum into account in preparing their bids, the Employer may, at its discretion, extend the deadline for the submission of bids, pursuant to **ITB 22.2**

Preparation of Bids

- 9. Cost of Bidding** 9.1 The Bidder shall bear all costs associated with the preparation and submission of its Bid, and the Employer shall not be responsible or liable for those costs, regardless of the conduct or outcome of the bidding process.
- 10. Language of Bid** 10.1 The Bid, as well as all correspondence and documents relating to the bid exchanged by the Bidder and the Employer, shall be written in the language specified in the **BDS**. Supporting documents and printed literature that are part of the Bid may be in another language provided they are accompanied by an accurate translation of the relevant passages in that language, in which case, for purposes of interpretation of the Bid, such translation shall govern.
- 11. Documents Comprising the Bid** 11.1 The Bid shall comprise the following:
- (a) Letter of Bid

- (b) Completed Schedules as provided in Section IV, Bidding Forms;
- (c) Bid Security or Bid-Securing Declaration, in accordance with **ITB 19**;
- (d) at the Bidder's option, alternative proposals, if permissible, in accordance with **ITB 13**;
- (e) written confirmation authorizing the signatory of the Bid to commit the Bidder, in accordance with **ITB 20.2**;
- (f) documentary evidence establishing the eligibility of the Goods and Related Services offered by the Bidder, in accordance with **ITB 17.1**;
- (g) documentary evidence establishing the Bidder's qualifications in accordance with the requirements of Section III, Evaluation and Qualification Criteria, using the relevant forms furnished in Section IV, Bidding Forms;
- (h) documentary evidence as specified in the **BDS**, establishing the conformity of the Technical Proposal offered by the Bidder with the Bidding Document, using the relevant forms furnished in Section IV, Bidding Forms;
- (i) in the case of a bid submitted by a JVCA, JVCA agreement, or letter of intent to enter into a JVCA including a draft agreement, indicating at least the parts of the Requirements to be executed by the respective partners;
- (j) any other document required in the **BDS**.

12. Letter of Bid and Price Schedules

12.1 The Bidder shall submit the Letter of Bid using the form furnished in Section IV, Bidding Forms. This form must be completed without any alterations to its format, and no substitutes shall be accepted. All blank spaces shall be filled in with the information requested.

13. Alternative Bids

13.1 Unless otherwise indicated in the **BDS**, alternative proposals shall not be considered. If alternative proposals are permitted, their method of evaluation shall be as stipulated in Section III, Evaluation and Qualification Criteria.

13.2 When alternative times for completion are explicitly invited, a statement to that effect will be included in the **BDS**, as well as the method of evaluating different times for completion.

13.3 Except as provided under **ITB 13.4** below, Bidders wishing to offer technical alternatives to the requirements of the bidding document

must first price the Employer's requirements as described in the bidding document and shall further provide all information necessary for a complete evaluation of the alternative by the Employer, including drawings, design calculations, technical specifications, breakdown of prices, and proposed construction methodology and other relevant details. Only the technical alternatives, if any, of the lowest evaluated Bidder conforming to the basic technical requirements shall be considered by the Employer.

13.4 When specified in the **BDS**, Bidders are permitted to submit alternative technical solutions for specified parts of the requirements, and such parts shall be identified in the **BDS**, as will the method for their evaluation, and described in Section VI, Requirements.

14. Bid Prices and Discounts

14.1 The prices and discounts quoted by the Bidder in the Letter of Bid and in the Price Schedules shall conform to the requirements specified in **ITB 14.2**.

14.2 Unless otherwise provided in the **BDS** and the **General Conditions (GC)**, the prices quoted by the Bidder shall be fixed.

14.3 The Bidder shall submit a bid for the whole of the works described in **ITB 1.1** by filling in prices for all items of the Works, as identified in Section IV, Bidding Forms. In case of admeasurement contracts, the Bidder shall fill in rates and prices for all items of the Works described in the Bill of Quantities. Items against which no rate or price is entered by the Bidder will not be paid for by the Employer when executed and shall be deemed covered by the rates for other items and prices in the Bill of Quantities.

14.4 The price to be quoted in the Letter of Bid shall be the total price of the Bid, excluding any discounts offered.

14.5 Unconditional discounts, if any, and the methodology for their application shall be quoted in the Letter of Bid, in accordance with **ITB 12.1**.

14.6 If, pursuant to **ITB 14.2**, prices are adjustable, the Bidder shall furnish the indices and weightings for the price adjustment formula in the Schedule of Adjustment Data in Section IV (Bidding Forms) and the Employer may require the Bidder to justify its proposed indices and weightings.

14.7 If so indicated in **ITB 1.1**, bids are invited for individual contracts or for any combination of contracts (packages). Bidders wishing to offer any price reduction for the award of more than one Contract shall specify in their bid the price reductions applicable to each package, or alternatively, to individual Contracts within the package. Price reductions or discounts shall be submitted in accordance with **ITB**

- 14.5, provided the bids for all contracts are submitted and opened at the same time.
- 14.8 All duties, taxes, and other levies payable by the Contractor under the Contract, or for any other cause, as of the date 28 days prior to the deadline for submission of bids, shall be included in the rates and prices and the total bid price submitted by the Bidder.
- 15. Currencies of Bid and Payment**
- 15.1 The currency(ies) of the bid and the currency(ies) for payment shall be as specified in the **BDS**.
- 16. Documents Establishing the Qualifications of the Bidder**
- 16.1 To establish its qualifications to perform the Contract in accordance with Section III, Evaluation and Qualification Criteria, the Bidder shall provide the information requested in Section IV, Bidding Forms.
- 16.2 Bidders, individually or in joint ventures, applying for eligibility for margin of preference, if such margin applies pursuant to **ITB 31.2**, shall supply all information required to satisfy the criteria for eligibility as described in **ITB 31.2**.
- 17. Documents Establishing the Eligibility of the Goods and Related Services**
- 17.1 To establish the eligibility of the Goods and Related Services in accordance with **ITB Clause 5**, Bidders shall complete the forms, included in Section IV, Bidding Forms.
- 18. Period of Validity of Bids**
- 18.1 Bids shall remain valid for the period specified in the **BDS** after the bid submission deadline date prescribed by the Employer. A bid valid for a shorter period shall be rejected by the Employer as non-responsive.
- 18.2 In exceptional circumstances, prior to the expiration of the bid validity period, the Employer may request Bidders to extend the period of validity of their bids. The request and the responses shall be made in writing. If a bid security is requested in accordance with **ITB 19**, the Bidder granting the request shall also extend the bid security for twenty-eight (28) days beyond the deadline of the extended validity period. A Bidder may refuse the request without forfeiting its bid security. A Bidder granting the request shall not be required or permitted to modify its bid, except as provided in **ITB 18.3**.
- 18.3 In the case of fixed price contracts, if the award is delayed by a period exceeding fifty-six (56) days beyond the expiry of the initial bid validity, the Contract price shall be adjusted as specified in the request for extension. Bid evaluation shall be based on the Bid Price without taking into consideration the above correction.

19. Bid Security

- 19.1 The Bidder shall furnish as part of its bid, at the option of the Employer, and as stipulated in the **BDS**, the original of either a Bid-Securing Declaration or a bid security using the relevant form included in Section IV, Bidding Forms. In the case of a bid security, the bid security amount and currency shall be as specified in the **BDS**.
- 19.2 A Bid-Securing Declaration shall use the form included in Section IV, Bidding Forms.
- 19.3 If a bid security is specified pursuant to **ITB** 19.1, the bid security shall be a demand guarantee in any of the following forms at the Bidder's option:
- (a) an unconditional guarantee issued by a bank or surety;
 - (b) an irrevocable letter of credit; or
 - (c) a cashier's or certified check;
- from a reputable source from an eligible country. If the unconditional guarantee is issued by an insurance company or a bonding company located outside the Employer's Country, the issuer shall have a correspondent financial institution located in the Employer's Country to make it enforceable. In the case of a bank guarantee, the bid security shall be submitted either using the Bid Security Form included in Section IV, Bidding Forms or in another substantially similar format approved by the Employer prior to bid submission. In either case, the form must include the complete name of the Bidder. The bid security shall be valid for twenty-eight days (28) beyond the original validity period of the bid, or beyond any period of extension if requested under **ITB** 18.2.
- 19.4 Pursuant to the option stipulated at **ITB** 19.1, any bid not accompanied by a substantially responsive bid security or Bid-Securing Declaration shall be rejected by the Employer as non-responsive.
- 19.5 If a bid security is specified pursuant to **ITB** 19.1, the bid security of unsuccessful Bidders shall be returned as promptly as possible upon the successful Bidder's furnishing of the performance security pursuant to **ITB** 38.
- 19.6 The bid security of the successful Bidder shall be returned as promptly as possible once the successful Bidder has signed the Contract and furnished the required performance security.
- 19.7 The bid security may be forfeited or the Bid-Securing Declaration executed:
- (a) if a Bidder withdraws its bid during the period of bid validity specified by the Bidder in the Letter of Bid or

- (b) if the successful Bidder fails to:
 - (i) sign the Contract in accordance with **ITB 37**; or
 - (ii) furnish a performance security in accordance with **ITB 38**.

19.8 The Bid Security or the Bid Securing Declaration of a JVCA shall be in the name of the JVCA that submits the bid. If the JVCA has not been legally constituted into a legally enforceable JVCA at the time of bidding, the Bid Security or the Bid Securing Declaration shall be in the names of all future partners as named in the letter of intent referred to in **ITB 4.1**.

19.9 If a Bid-Securing Declaration is executed in accordance with **ITB 19.7**, the Employer will declare the Bidder ineligible to be awarded a contract by the Employer for the period of time stated in the Form of Bid-Securing Declaration.

20. Format and Signing of Bid

20.1 The Bidder shall prepare one original of the documents comprising the bid as described in **ITB 11** and clearly mark it "ORIGINAL." In addition, the Bidder shall submit copies of the bid, in the number specified in the **BDS** and clearly mark them "COPY." In the event of any discrepancy between the original and the copies, the original shall prevail.

20.2 The original and all copies of the bid shall be typed or written in indelible ink and shall be signed by a person duly authorized to sign on behalf of the Bidder. This authorization shall consist of a written confirmation as specified in the **BDS** and shall be attached to the bid. The name and position held by each person signing the authorization must be typed or printed below the signature. All pages of the bid where entries have been made shall be signed or initialled by the person signing the bid.

20.3 A bid submitted by a JVCA shall comply with the following requirements:

- (a) Unless not required in accordance with **ITB 4.1 (a)**, be signed so as to be legally binding on all partners and
- (b) Include the Representative's authorization referred to in **ITB 4.1 (b)**, consisting of a power of attorney signed by those legally authorized to sign on behalf of the JVCA.

20.4 Any amendments, interlineations, erasures, or overwriting shall be valid only if they are signed or initialled by the person signing the bid.

Submission and Opening of Bids

- 21. Submission, Sealing and Marking of Bids**
- 21.1 Bidders may always submit their bids by mail or by hand. If so specified in the **BDS**, bidders shall have the option of submitting their bids electronically. Procedures for submission, sealing and marking are as follows:
- (a) Bidders submitting bids by mail or by hand shall enclose the original and copies of the Bid in separate sealed envelopes. If so permitted in accordance with **ITB 13**, alternative proposals, and copies thereof, shall also be placed in separate envelopes. The envelopes shall be duly marked as “ORIGINAL,” “ALTERNATIVE,” “ORIGINAL COPY,” and “ALTERNATIVE COPY” These envelopes shall then be enclosed in one single package. The rest of the procedure shall be in accordance with **ITB 21.2** and **21.3**.
 - (b) Bidders submitting bids electronically shall follow the electronic bid submission procedures specified in the **BDS**.
- 21.2 The inner and outer envelopes shall:
- (a) bear the name and address of the Bidder;
 - (b) be addressed to the Employer in accordance with **ITB 22.1**;
 - (c) bear the specific identification of this bidding process pursuant to **ITB 1.1**; and
 - (d) bear a warning not to open before the time and date for bid opening
- 21.3 If envelopes and packages are not sealed and marked as required, the Employer will assume no responsibility for the misplacement or premature opening of the bid.
- 22. Deadline for Submission of Bids**
- 22.1 Bids must be received by the Employer at the address and no later than the date and time indicated in the **BDS**.
- 22.2 The Employer may, at its discretion, extend the deadline for the submission of bids by amending the Bidding Document in accordance with **ITB 8**, in which case all rights and obligations of the Employer and Bidders previously subject to the deadline shall thereafter be subject to the deadline as extended.
- 23. Late Bids**
- 23.1 The Employer shall not consider any bid that arrives after the deadline for submission of bids, in accordance with **ITB 22**. Any bid received by the Employer after the deadline for submission of bids shall be declared late, rejected, and returned unopened to the Bidder.
- 24. Withdrawal, Substitution,**
- 24.1 A Bidder may withdraw, substitute, or modify its bid after it has been submitted by sending a written notice, duly signed by an authorized

**and
Modification of
Bids**

representative, and shall include a copy of the authorization in accordance with **ITB 20.2.**, (except that withdrawal notices do not require copies). The corresponding substitution or modification of the bid must accompany the respective written notice. All notices must be:

- (a) prepared and submitted in accordance with **ITB 20** and **ITB 21** (except that withdrawals notices do not require copies), and in addition, the respective envelopes shall be clearly marked “WITHDRAWAL,” “SUBSTITUTION,” “MODIFICATION;” and
- (b) received by the Employer prior to the deadline prescribed for submission of bids, in accordance with **ITB 22.**

24.2 Bids requested to be withdrawn in accordance with **ITB 24.1** shall be returned unopened to the Bidders.

24.3 No bid may be withdrawn, substituted, or modified in the interval between the deadline for submission of bids and the expiration of the period of bid validity specified by the Bidder on the Letter of Bid or any extension thereof.

25. Bid Opening

25.1 The Employer shall conduct the bid opening in public, in the presence of Bidders` designated representatives and anyone who choose to attend, and at the address, date and time specified in the **BDS**. Any specific electronic bid opening procedures required if electronic bidding is permitted in accordance with **ITB 21.1**, shall be as specified in the **BDS**.

25.2 First, envelopes marked “Withdrawal” shall be opened and read out and the envelope with the corresponding bid shall not be opened, but returned to the Bidder. No bid withdrawal shall be permitted unless the corresponding withdrawal notice contains a valid authorization to request the withdrawal and is read out at bid opening. Next, envelopes marked “Substitution” shall be opened and read out and exchanged with the corresponding bid being substituted, and the substituted bid shall not be opened, but returned to the Bidder. No bid substitution shall be permitted unless the corresponding substitution notice contains a valid authorization to request the substitution and is read out at bid opening. Envelopes marked “Modification” shall be opened and read out with the corresponding bid. No bid modification shall be permitted unless the corresponding modification notice contains a valid authorization to request the modification and is read out at bid opening. Only bids that are opened and read out at bid opening shall be considered further.

25.3 The Employer shall open all other envelopes one at a time and read out: the name of the Bidder, the Bid Price(s), any discounts and their application methodology, alternative bids, the presence or absence of

a bid security or Bid-Securing Declaration; and any other details as the Employer may consider appropriate. Only discounts and alternative bids read out at bid opening shall be considered for evaluation. No bid shall be rejected at bid opening except for late bids, in accordance with **ITB 23.1**.

25.4 The Employer shall prepare a record of the bid opening that shall include, as a minimum: the name of the Bidder and whether there is a withdrawal, substitution, or modification; the Bid Price, per lot if applicable, including any discounts and alternative proposals; and the presence or absence of a bid security or a Bid-Securing Declaration. The Bidders' representatives who are present shall be requested to sign the record. The omission of a Bidder's signature on the record shall not invalidate the contents and effect of the record. A copy of the record shall be distributed to all Bidders who submitted bids in time, and posted online when electronic bidding is permitted.

Examination of Bids

- 26. Confidentiality**
- 26.1 Information relating to the evaluation of bids shall not be disclosed to Bidders or any other persons not officially concerned with such process until information on Contract award is communicated to all Bidders.
- 26.2 Any attempt by a Bidder to influence improperly the Employer in the evaluation of the bids or Contract award decisions may result in the rejection of its bid.
- 26.3 Notwithstanding **ITB 26.1**, from the time of bid opening to the time of Contract award, if any Bidder wishes to contact the Employer on any matter related to the bidding process, it should do so in writing.
- 27. Clarification of Bids**
- 27.1 To assist in the examination, evaluation, and comparison of the bids, and qualification of the Bidders, the Employer may, at its discretion, ask any Bidder for a clarification of its bid, allowing a reasonable time for response. Any clarification submitted by a Bidder that is not in response to a request by the Employer shall not be considered. The Employer's request for clarification and the response shall be in writing. No change in the prices or substance of the bid shall be sought, offered, or permitted, except to confirm the correction of arithmetic errors discovered by the Employer in the evaluation of the bids, in accordance with **ITB 29**.
- 27.2 If a Bidder does not provide clarifications of its bid by the date and time set in the Employer's request for clarification, its bid may be rejected.

28. Determination of Responsiveness

- 28.1 The Employer's determination of a bid's responsiveness is to be based on the contents of the bid itself, as defined in **ITB11**.
- 28.2 A substantially responsive bid is one that meets the requirements of the Bidding Document without material deviation, reservation, or omission.
- (a) "Deviation" is a departure from the requirements specified in the Bidding Document;
 - (b) "Reservation" is the setting of limiting conditions or withholding from complete acceptance of the requirements specified in the Bidding Document; and
 - (c) "Omission" is the failure to submit part or all of the information or documentation required in the Bidding Document.
- 28.3 A material deviation, reservation, or omission is one that,
- (a) if accepted, would:
 - (i) affect in any substantial way the scope, quality, or performance of the Schedule of Requirements as specified in Section VI; or
 - (ii) limit in any substantial way, inconsistent with the Bidding Document, the Employer's rights or the Bidder's obligations under the proposed Contract; or
 - (b) if rectified, would unfairly affect the competitive position of other Bidders presenting substantially responsive bids.
- 28.4 The Employer shall examine the technical aspects of the bid in particular, to confirm that all requirements of Section VI have been met without any material deviation, reservation, or omission.
- 28.5 If a bid is not substantially responsive to the requirements of the Bidding Document, it shall be rejected by the Employer and may not subsequently be made responsive by correction of the material deviation, reservation, or omission.
- 28.6 Provided that a bid is substantially responsive, the Employer may waive any quantifiable nonconformity in the bid that does not constitute a material deviation, reservation or omission.
- 28.7 Provided that a bid is substantially responsive, the Employer may request that the Bidder submit the necessary information or documentation, within a reasonable period of time, to rectify nonmaterial nonconformities in the bid related to documentation

requirements. Requesting information or documentation on such nonconformities shall not be related to any aspect of the price of the bid. Failure of the Bidder to comply with the request may result in the rejection of its bid.

- 28.8 Provided that a bid is substantially responsive, the Employer shall rectify quantifiable nonmaterial nonconformities related to the Bid Price. To this effect, the Bid Price shall be adjusted, for comparison purposes only, to reflect the price of the non-conforming item or component. The adjustment shall be made using the methodology indicated in Section III, Evaluation and Qualification Criteria.

Bid Evaluation and Comparison

29. Correction of Arithmetical Errors

- 29.1 The Employer shall use the criteria and methodologies indicated in Section III, Evaluation and Qualification Criteria. No other evaluation criteria or methodologies shall be permitted
- 29.2 Provided that the bid is substantially responsive, the Employer shall correct arithmetical errors as indicated in Section III, Evaluation and Qualification Criteria
- 29.3 If a Bidder does not accept the correction of errors, its bid shall be declared non-responsive and its Bid Security shall be forfeited or the Bid-Securing Declaration executed.

30. Conversion to Single Currency

- 30.1 For evaluation and comparison purposes, the currency(ies) of the bid shall be converted into a single currency as specified in Section III, Evaluation and Qualification Criteria.

31. Bid Adjustments

- 31.1 For evaluation and comparison purposes the Employer shall adjust the bid prices using the criteria and methodology specified in Section III, Evaluation and Qualification Criteria.
- 31.2 Unless otherwise specified in the **BDS**, no margin of domestic or regional preference shall apply. If a margin of preference applies, the application methodology shall be as specified in Section III, Evaluation and Qualification Criteria, and in accordance with the provisions stipulated in the Bank's **Rules and Procedures for Procurement of Goods and Works**.
- 31.3 If in the opinion of the Employer the bid which results in the lowest Evaluated Bid, is seriously unbalanced or front loaded or substantially below the Employer's estimates, the Employer may require the Bidder to produce detailed price analyses for any or all items of the Bill of Quantities, to demonstrate the internal consistency of those prices with the methods and schedule proposed. After evaluation of the price analyses, taking into consideration the schedule of estimated Contract payments, the Employer may require

that the amount of the performance security be increased at the expense of the Bidder to a level sufficient to protect the Employer against financial loss in the event of default of the successful Bidder under the Contract.

32. Qualification of the Bidder

32.1 The Employer shall determine to its satisfaction whether the Bidder that is selected as having submitted the lowest evaluated and substantially responsive bid meets the qualifying criteria specified in Section III, Evaluation and Qualification Criteria.

32.2 The determination shall be based upon an examination of the documentary evidence of the Bidder's qualifications submitted by the Bidder, pursuant to **ITB 16**.

32.3 An affirmative determination shall be a prerequisite for award of the Contract to the Bidder. A negative determination shall result in disqualification of the bid, in which event the Employer shall proceed to the next lowest evaluated bid to make a similar determination of that Bidder's qualifications to perform satisfactorily.

32.4 The capabilities of the manufacturers and subcontractors proposed in its Bid to be used by the lowest evaluated Bidder for identified major items of the Requirements will also be evaluated for acceptability in accordance with the criteria and methodologies defined in Section III, Evaluation and Qualification Criteria. Their participation should be confirmed with a letter of intent between the parties, as needed. Should a manufacturer or subcontractor be determined to be unacceptable, the Bid will not be rejected, but the Bidder will be required to substitute an acceptable manufacturer or subcontractor without any change to the bid price.

33. Comparison of Bid

33.1 Subject to **ITB 29, 30 and 31**, the Employer shall compare all substantially responsive bids to determine the lowest evaluated bid.

34. Employer's Right to Accept Any Bid, and to Reject Any or All Bids

34.1 The Employer reserves the right to accept or reject any bid, and to annul the bidding process and reject all bids at any time prior to contract award, without thereby incurring any liability to Bidders. In case of annulment, all bids submitted and specifically, bid securities, shall be promptly returned to the Bidders.

Award of Contract

35. Award Criteria

35.1 Subject to **ITB 34.1**, the Employer shall award the Contract to the Bidder whose offer has been determined to be the lowest evaluated bid and is substantially responsive to the Bidding Document, provided further that the Bidder is determined to be qualified to perform the Contract satisfactorily.

36. Notification of Award

- 36.1 Prior to the expiration of the period of bid validity, the Employer shall notify the successful Bidder, in writing, that its bid has been accepted. The notification letter (hereinafter and in the Conditions of Contract and Contract Forms called the “Letter of Acceptance”) shall specify the sum that the Employer will pay the Contractor in consideration of the execution and completion of the Works (hereinafter and in the Contract Forms called “the Contract Price”).
- 36.2 Until a formal contract is prepared and executed, the notification of award shall constitute a binding Contract.
- 36.3 At the same time, the Employer shall also notify all other Bidders of the results of the bidding process, and shall publish in **UNDB online** and at the **Bank’s website** (www.afdb.org), the results identifying the bid and lot numbers and the following information: (i) name of each Bidder who submitted a Bid; (ii) bid prices as read out at bid opening; (iii) name and evaluated prices of each Bid that was evaluated; (iv) name of bidders whose bids were rejected and the reasons for their rejection; and (v) name of the winning Bidder, and the price it offered, as well as the duration and summary scope of the contract awarded. After publication of the award, unsuccessful bidders may request in writing to the Employer for a debriefing seeking explanations on the grounds on which their bids were not selected. The Employer shall promptly respond in writing to any unsuccessful Bidder who, after Publication of contract award, requests a debriefing.

37. Signing of Contract

- 37.1 Promptly upon notification, the Employer shall send the successful Bidder the Contract Agreement.
- 37.2 Within twenty-eight (28) days of receipt of the Contract Agreement, the successful Bidder shall sign, date, and return it to the Employer.
- 37.3 Upon the successful Bidder’s furnishing of the signed Contract Agreement and Performance Security pursuant to **ITB 38**, the Employer will discharge its Bid Security, pursuant to **ITB 19**.
- 37.4 Notwithstanding **ITB 37.2** above, in case signing of the Contract Agreement is prevented by any export restrictions attributable to the Employer, to the country of the Employer, or to the use of the products/goods, systems or services to be supplied, where such export restrictions arise from trade regulations from a country supplying those products/goods, systems or services, the Bidder shall not be bound by its bid, always provided, however, that the Bidder can demonstrate to the satisfaction of the Employer and of the Bank that signing of the Contract Agreement has not been prevented by any lack of diligence on the part of the Bidder in completing any formalities, including applying for permits, authorizations and licenses necessary

for the export of the products/goods, systems or services under the terms of the Contract Agreement.

**38. Performance
Security**

- 38.1 Within twenty-eight (28) days of the receipt of notification of award from the Employer, the successful Bidder shall furnish the performance security in accordance with the conditions of contract, subject to **ITB** 31.3, using for that purpose the Performance Security Form included in Section IX, Contract Forms, or another form acceptable to the Employer. If the performance security furnished by the successful Bidder is in the form of a bond, it shall be issued by a bonding or insurance company that has been determined by the successful Bidder to be acceptable to the Employer. A foreign institution providing a bond shall have a correspondent financial institution located in the Employer's Country.
- 38.2 Failure of the successful Bidder to submit the above-mentioned Performance Security or sign the Contract shall constitute sufficient grounds for the annulment of the award and forfeiture of the bid security, or execution of the Bid-Securing Declaration. In that event the Employer may award the Contract to the next lowest evaluated Bidder whose offer is substantially responsive and is determined by the Employer to be qualified to perform the Contract satisfactorily.

Section II. Bid Data Sheet

A. General	
ITB 1.1	The number of the Invitation for Bids is: MOALD/SIVAP/T040/2023-2024
ITB 1.1	The Employer is: Principal Secretary, State Department for Crop Development, Ministry of Agriculture and Livestock Development
ITB 1.1	The name of the bidding process is: National Competitive Bidding The identification number of the bidding process is: MOALD/SIVAP/T040/2023-2024 The number and identification of lots comprising this bidding process are: N/A
ITB 2.1	The Borrower is: Republic of Kenya
ITB 2.1	The specific Bank financing institution is: African Development Fund
ITB 2.1	The name of the Project is: Small Scale Irrigation and Value Addition Project
ITB 4.1(a)	The individuals or firms in a joint venture, consortium or association “shall be” jointly and severally liable.
ITB 4.4	A list of debarred firms is available at http://www.afdb.org/debarred
B. Contents of Bidding Document	
ITB 7.1	Attention: Project Coordinator Street Address: Hill Plaza, Ngong Road P.O. Box 30028-00100 Nairobi, Kenya Floor/Room number: 9th Floor City: Nairobi ZIP Code: N/A Country: KENYA Electronic mail address: npcsivap@gmail.com Requests for clarifications should be received by the Employer no later than ten (10) days , prior to the deadline for submission of Bids.
ITB 7.4	A Pre-Bid meeting “shall not” take place.

C. Preparation of Bids	
ITB 10.1	The language of the bid is: English
ITB 11.1 (h)	The Bidder must provide the following Documentary Evidence to establish the conformity of the Technical Proposal with the Bidding Document: <ul style="list-style-type: none"> • Certificate of registration/incorporation • Evidence of similar works undertaken in the past two years • List of equipment proposed for the works (provide proof of ownership, lease or hire) • List of proposed personnel, signed CV's and clear proposed positions/tasks for each • Audited financial statements for the last three years • Clear work program/plan and methodology
ITB 11.1 (j)	The Bidder shall submit with its bid the following additional documents: <ul style="list-style-type: none"> • Copy of the Bidder's VAT registration certificate or equivalent • A valid tax compliance certificate • Written authorization for the person signing the documents from the company/Power of Attorney • Joint venture agreement, in the required format, for those submitting bids as joint ventures • A bid guarantee from a Bank in the format given/attached and shall be valid for twenty-eight days (28) beyond the original validity period of the bid • Duly filled and signed letter of bid in the company letterhead and in the format attached.
ITB 13.1	Alternative bids are not permitted.
ITB 13.2	Alternatives to the Times for Completion " shall not be " permitted. If alternatives to the Times for Completion are permitted, the evaluation method will be as specified in Section III, Evaluation and Qualification Criteria.
ITB 13.4	Alternative technical solutions shall be permitted for the following parts of the Works, as further detailed in the Specification: " none ".
ITB 14.2	Prices " shall be " fixed.
ITB 14.6	The prices quoted by the Bidder " shall not be " subject to adjustment during the performance of the Contract.
ITB 15.1	The currency of the bid and payment shall be: Kenya Shilling (KES)
ITB 18.1	The bid validity period shall be: 120 days.

ITB 19.1	The Bidder shall furnish a bid security, in the amount of KES 240,000.00 – Bank Guarantee
ITB 20.1	In addition to the original of the Bid, the number of copies is: 1 copy
ITB 20.2	<p>The written confirmation of authorization to sign on behalf of the Bidder shall indicate:</p> <p>(a) The name and description of the documentation required to demonstrate the authority of the signatory to sign the Bid such as a Power of Attorney, authorization letter in company stationery; and</p> <p>(b) In the case of Bids submitted by an existing or intended JVCA an undertaking signed by all parties (i) stating that all parties shall be jointly and severally liable, if so required in accordance with ITB 4.1(a), and (ii) nominating a Representative who shall have the authority to conduct all business for and on behalf of any and all the parties of the JVCA during the bidding process and, in the event the JV is awarded the Contract, during contract execution.”]</p>
D. Submission and Opening of Bids	
ITB 21.1	Bidders “ shall not ” have the option of submitting their bids electronically.
ITB 21.1 (b)	The electronic bidding submission procedures shall be: None
ITB 22.1	<p>For <u>bid submission purposes</u> only, the Employer’s address is :</p> <p>Attention: Principal Secretary, State Department for Crops Development Street Address: Cathedral Road Floor/Room number: Ground Floor, State Department of Agriculture Tender Box City: Nairobi ZIP Code: P.O. Box 30028-00100 Nairobi, Kenya Country: KENYA</p> <p>The deadline for bid submission is: Date: 05-09-2023 Time: 11.00am</p>
ITB 25.1	<p>The bid opening shall take place at: Street Address: Cathedral Road, State Department for Crops Development, Floor/Room number: 7th Floor Conference Room, Kilimo House City : Nairobi Country: Kenya Date:05-09-2023 Time: 11.00am</p>

ITB 25.1	The electronic bid opening procedures shall be: None
F. Bid Evaluation and Comparison	
ITB 31.2	A margin of domestic or regional preference “ shall not ” apply.

Section III. Evaluation and Qualification Criteria

1. **Evaluation Criteria and Methodology**

1.1 **Alternative Proposal (If permitted in accordance with ITB 13.1)**

Technical Alternative **None**

Alternative Time for Completion **None**

1.2 **Correction of Arithmetical Errors (In accordance with ITB 29.1)**

(a) Where there are errors between the total of the amounts given under the column for the price breakdown and the amount given under the Total Price, the former shall prevail and the latter will be corrected accordingly

(b) If there is a discrepancy between the unit price and the total price that is obtained by multiplying the unit price and quantity, the unit price shall prevail and the total price shall be corrected, unless in the opinion of the Employer there is an obvious misplacement of the decimal point in the unit price, in which case the total price as quoted shall govern and the unit price shall be corrected;

(c) If there is an error in a total corresponding to the addition or subtraction of subtotals, the subtotals shall prevail and the total shall be corrected; and

(d) If there is a discrepancy between words and figures, the amount in words shall prevail, unless the amount expressed in words is related to an arithmetic error, in which case the amount in figures shall prevail subject to (a) and (b) above.

1.3 **Conversion to a Single Currency (In accordance with ITB 30)**

Not applicable.

1.4 **Discounts (In accordance with ITB 14.5)**

The Employer will adjust the Bid Price, using the methodology prescribed by the Bidder in its Letter of Bid, to take account of the Discounts offered by the Bidder in its Letter of Bid, as read out at the Bid Opening.

1.5 **Quantifiable Nonmaterial Nonconformities (In accordance with ITB 28.8)**

The adjustment shall be made using the following methodology: **[insert methodology]**

1.6 Margin of Domestic or Regional Preference (If permitted in accordance with ITB 31.2)

None

1.7 Any other Criteria or Methodology

See Section II & Section VIII

2. Qualification Criteria

2	Qualification (Without Prequalification)
2.1	Eligibility (TABLE)
2.2	Historical Contract Non-Performance (TABLE)
2.3	Financial Situation (TABLE)
2.4	Experience (TABLE)
2.5	Personnel (TABLE)
2.6	Equipment (TABLE)

2. Qualification Tables (Without Prequalification)

Factor	2.1 Eligibility					
Sub-Factor	Requirement	Criteria				Documentation Required
		Single Entity	Bidder			
			All partners combined	Each partner	At least one partner	
2.1.1 Nationality	Nationality in accordance with ITB 4.2.	Must meet requirement	Existing or intended JVCA must meet requirement	Must meet requirement	N / A	Form ELI –1.1 and 1.2, with attachments
2.1.2 Conflict of Interest	No- conflicts of interests as described in ITB 4.3.	Must meet requirement	Existing or intended JVCA must meet requirement	Must meet requirement	N / A	Letter of Bid
2.1.3 Bank Ineligibility	Not having been declared ineligible by the Bank as described in ITB 4.4.	Must meet requirement	Existing JVCA must meet requirement	Must meet requirement	N / A	Letter of Bid
2.1.4 Government Owned Entity	Compliance with conditions of ITB 4.5	Must meet requirement	Must meet requirement	Must meet requirement	N / A	Form ELI –1.1 and 1.2, with attachments
2.1.5 Ineligibility based on a United Nations resolution or Borrower’s country law	Not having been excluded as a result of the Borrower’s country laws or official regulations, or by an act of compliance with UN Security Council resolution, in accordance with ITB 4.8	Must meet requirement	Existing JVCA must meet requirement	Must meet requirement	N / A	Letter of Bid

Factor	2.2 Historical Contract Non-Performance					
Sub-Factor	Criteria					Documentati on Required
	Requirement	Bidder				
		Single Entity	Joint Venture, Consortium or Association			
All partners combined			Each partner	At least one partner		
2.2.1 History of non-performing contracts	Non-performance of a contract did not occur within the last two (2) years prior to the deadline for application submission, based on all information on fully settled disputes or litigation. A fully settled dispute or litigation is one that has been resolved in accordance with the Dispute Resolution Mechanism under the respective contract, and where all appeal instances available to the bidder have been exhausted.	Must meet requirement by itself or as partner to past or existing JVCA	N / A	Must meet requirement by itself or as partner to past or existing JVCA	N / A	Form CON - 2
2.2.2 Failure to Sign Contract	Not being under execution of Bid-Securing Declaration pursuant to ITB 4.6 for two (2)No years	Must meet requirement	N / A	Must meet requirement by itself or as partner to a JVCA	N / A	Letter of Bid
2.2.3 Pending Litigation	All pending litigation shall in total not represent more than five percent (5%) of the Bidder's net worth and shall be treated as resolved against the Bidder.	Must meet requirement by itself or as partner to past or existing JVCA	N / A	Must meet requirement by itself or as partner to past or existing JVCA	N / A	Form CON – 2

Factor	2.3 Financial Situation					
Sub-Factor	Criteria					Documentation Required
	Requirement	Bidder				
		Single Entity	Joint Venture, Consortium or Association			
All partners combined			Each partner	At least one partner		
2.3.1 Historical Financial Performance	Submission of audited balance sheets or if not required by the law of the bidder's country, other financial statements acceptable to the Employer, for the last three[3No] years to demonstrate the current soundness of the bidders financial position and its prospective long term profitability. (a) Audited accounts in comparative form (b) Valid Tax Compliance (c) Cash flow statements (Supported by Bank statements)	Must meet requirement	N / A	Must meet requirement	N / A	Form FIN – 3.1 with attachments
2.3.2. Average Annual Turnover	Minimum average annual turnover of KES 5 million , calculated as total certified payments received for contracts in progress or completed, within the last three (3No) years	Must meet requirement	Must meet requirement	Must meet _____ percent (____%) of the requirement	Must meet _____ percent (____%) of the requirement	Form FIN –3.2

Factor	2.3 Financial Situation					
Sub-Factor	Criteria					Documentation Required
	Requirement	Bidder				
		Single Entity	Joint Venture, Consortium or Association			
All partners combined			Each partner	At least one partner		
2.3.3. Financial Resources	The Bidder must demonstrate access to, or availability of, financial resources such as liquid assets, unencumbered real assets, lines of credit, and other financial means, other than any contractual advance payments to meet: (i) the following cash-flow requirement: $\text{Current ratio} = \frac{\text{Liquid Assets}}{\text{Liquid liabilities}}$ Greater than 1 and $\text{Debt Ratio} = \frac{\text{Total Debt}}{\text{Total Assets}}$ Less than 1 and (ii) the overall cash flow requirements for this contract and its current commitments.	Must meet requirement	Must meet requirement	Must meet fifty percent (50%) of the requirement	Must meet seventy five percent (75%) of the requirement	Form FIN –3.3 + Form CCC

Factor	2.4 Experience					
Sub-Factor	Criteria					Documentation Required
	Requirement	Bidder				
		Single Entity	Joint Venture, Consortium or Association			
All partners combined			Each partner	At least one partner		
2.4.1 General Experience	Experience under contracts in the role of contractor, subcontractor, or management contractor for at least the last two [2No] years prior to the applications submission deadline, and with an activity in at least nine (9) months in each year.	Must meet requirement	N / A	Must meet requirement	N / A	Form EXP-4.1
2.4.2 Specific Experience	(a)Participation as contractor, management contractor, or subcontractor, in at least two (2No) borehole drilling and equipping contracts of over 300m borehole depths within the last three (3No) years that have been successfully and substantially completed similar to the proposed Works. The similarity shall be based on the physical size, complexity, methods/technology or other characteristics as described in Section VI, Requirements.	Must meet requirement	Must meet requirements for all characteristics	N / A	Must meet requirement for one characteristic	Form EXP 2.4.2(a)
2.4.2 Specific Experience	b) For the above or other contracts executed during the period stipulated in 2.4.2(a) above, a minimum experience in the following key activities: 1. Drilling of boreholes 2. Pump Installation 3. Test pumping 4. Solar pump installation 5. Construction works	Must meet requirements	Must meet requirements	N / A	Must meet requirements	Form EXP-2.4.2(b)

2.5 Personnel

The Bidder must demonstrate that it will have the personnel for the key positions that meet the following requirements:

NO.	PERSONNEL	QUALIFICATION	NO.	Experience	REMARKS
1	Site Agent	Diploma in Civil Engineering/Water Engineering	1	5 years	All from recognized Institution
2	Geologist	Higher National Diploma/diploma in geologist/drilling technology	1	5 years	
2	Driller	Certificate in drilling	1	5 years	
3	Foreman	Certificate in Building Construction	1	5 years	
4	Welder	Certificate In welding	1	5 years	

The Bidder shall provide details of the proposed personnel and their experience records in the relevant Forms included in Section IV, Bidding Forms.

2.6 Equipment

The Bidder must demonstrate that it will have access to the key Contractor's equipment listed hereafter:

ITEM NO.	TYPE OF EQUIPMENT	NO.	CAPCITY	REMARKS
1	Drilling Rig preferably Lorry Mounted	1	Able drill up to 300m	
2	Lorry	1	10 ton	
3	Pick up	1	1 ton	

4	Water boozzer	1	5000 Litres	
5	Vibrator	1		
6	Concrete mixer	1		
7	Welding machine	1		
8	Mobile generator	1		
9	Grinder	1		

Section IV. Bidding Forms

Table of Forms

<u>Letter of Bid</u>	50
<u>Bill of Quantities/Schedules of Prices</u>	53
<u>Schedule of Adjustment Data</u>	75
<u>Summary of Payment Currencies</u>	76
<u>Form of Bid Security (Bank Guarantee)</u>	78
<u>Form of Bid Security (Bid Bond)</u>	80
<u>Form of Bid-Securing Declaration</u>	82
<u>Technical Proposal</u>	83
<u>Site Organization</u>	84
<u>Method Statement</u>	85
<u>Mobilization Schedule</u>	86
<u>Construction Schedule</u>	87
<u>Contractor's Equipment</u>	88
<u>Proposed Personnel</u>	89
<u>Resume of Proposed Personnel</u>	90
<u>Others</u>	91
<u>Bidder's Qualification</u>	92
<u>Bidder Information Sheet</u>	93
<u>Party to JVCA Information Sheet</u>	94
<u>Historical Contract Non-Performance</u>	95
<u>Current Contract Commitments / Works in Progress</u>	96
<u>Financial Situation</u>	97
<u>Average Annual Turnover</u>	99
<u>Financial Resources</u>	100
<u>General Experience</u>	101
<u>Specific Experience</u>	102
<u>Specific Experience in Key Activities</u>	104

Letter of Bid

The Bidder **MUST** prepare the Letter of Bid on stationery with its letterhead clearly showing the Bidder's complete name and address.

Date: _____
 Bidding No.: _____
 Invitation for Bid No.: _____

To:

We, the undersigned, declare that:

- (a) We have examined and have no reservations to the Bidding Documents, including Addenda issued in accordance with Instructions to Bidders (**ITB**) Clause 8;
- (b) We offer to execute in conformity with the Bidding Documents the following Works:
 _____;
- (c) The total price of our Bid, excluding any discounts offered in item (d) below is:
 _____;
- (d) The discounts offered and the methodology for their application are: _____;
- (e) Our bid shall be valid for a period of _____ [insert validity period as specified in **ITB** 18.1.] days from the date fixed for the bid submission deadline in accordance with the Bidding Documents, and it shall remain binding upon us and may be accepted at any time before the expiration of that period;
- (f) If price adjustment provisions apply, the Table(s) of Adjustment Data shall be considered part of this Bid;¹⁰
- (g) If our bid is accepted, we commit to obtain a performance security in accordance in accordance with **ITB** 38 and **GC** 5.15, for the due performance of the Contract;
- (h) Our firm, including any subcontractors or suppliers for any part of the Contract, have nationalities from eligible countries;

¹⁰ Include if price adjustment provisions apply in the Contract in accordance with **PC** Clause **5.10 Price Adjustment**.

- (i) We, including any subcontractors or suppliers for any part of the contract, do not have any conflict of interest in accordance with **ITB 4.3**;
- (j) We are not participating, as a Bidder or as a subcontractor, in more than one bid in this bidding process in accordance with **ITB 4.3**, other than alternative offers submitted in accordance with **ITB 13**;
- (k) Our firm, its affiliates or subsidiaries (including any Subcontractors or Suppliers for any part of the contract), has not been declared ineligible by the Bank, or under execution of a Bid-Securing Declaration in the Employer’s country, or under the Employer’s country laws or official regulations, or by an act of compliance with a decision of the United Nations Security Council, in accordance with **ITB 4.4, 4.6 and 4.8**, respectively;
- (l) We are not a government owned entity / We are a government owned entity but meet the requirements of **ITB 4.5**;¹¹
- (m) We are / are not under sanction by the World Bank, the IADB, EBRD or the AsDB for any action of corruption and fraud in accordance with **ITB 3**. [If under sanction, please provide details including date of start of sanction and duration].
- (n) We have paid, or will pay the following commissions, gratuities, or fees with respect to the bidding process or execution of the Contract: ¹²

Name of Recipient	Address	Reason	Amount
.....
.....

- (o) We undertake that, in competing for (and, if the award is made to us, in executing) the above contract, we will strictly observe the laws against fraud and corruption in force in the country of the Employer, as such laws have been listed by the Employer in the bidding documents for this contract.¹³
- (p) We understand that this bid, together with your written acceptance thereof included in your notification of award, shall constitute a binding contract between us, until a formal contract is prepared and executed;
- (q) We understand that you are not bound to accept the lowest evaluated bid or any other bid that you may receive; and
- (r) If awarded the contract, the person named below shall act as Contractor’s Representative:

- (s) We accept the appointment of **[Employer to insert full name and address of suggested appointee]** as the Adjudicator. / We do not accept the appointment of **[Bidder to insert**

¹¹ Use one of the two options as appropriate.
¹² If none has been paid or is to be paid, indicate “none”.
¹³ The Bank will accept the introduction of such undertaking at the request of the Borrowing country, provided the arrangements governing such undertaking are satisfactory to the Bank.

name suggested by Employer] as the Adjudicator, and propose instead that [**Bidder to insert alternative name]** be appointed as the Adjudicator, whose daily fees and biographical data are attached.¹⁴

Name:

In the capacity of:

Signed:

Duly authorized to
sign the Bid for and on
behalf of:

Date:

¹⁴ Use one of the two options as appropriate.

Bill of Quantities/Schedules of Prices

DRILLING OF DRILLING AND EQUIPPING OF KISEUNI COMMUNITY BOREHOLE IN MACHAKOS COUNTY.

Bill of Quantities/Schedules of Prices

ITEM	DESCRIPTION	OFFICIAL USE		TENDERER'S USE	
				AMOUNT	
<u>GRAND SUMMARY</u>					
		KSH	CTS	KSH	CTS
A.	Totals for the proposed drilling and equipping of Drilling of Drilling and Equipping of Kiseuni Community Borehole in Machakos county				
B.	Contingency Sum (10%)				
	Contract sum carried to form of tender				

	Amount In Words:
	Name Of Tenderer:
	Address:
	Sign:
	Date:
	Witness Name:
	Address:
	Sign:
	Date:

SUMMARY FOR DRILLING AND EQUIPPING OF KISEUNI COMMUNITY BOREHOLE IN MACHAKOS COUNTY.

Item	Description	Amount	
	SUMMARY: DRILLING AND EQUIPPING OF KISEUNI COMMUNITY BOREHOLE IN MACHAKOS COUNTY	Kshs	Cts
A.	BILL NO. 1 PRELIMINARIES AND GENERALS		
B.	BILL NO. 2 PROVISIONAL SUMS		
C.	BILL NO. 3: DRILLING, DEVELOPMENT and TEST PUMPING		
D.	BILL NO.4: SUPPLY AND INSTALLATION OF GRUNDFOS SOLAR PUMP		
E.	BILL NO.5: CONSTRUCTION OF WATER KIOSK WITH REINFORCED PLATFORM		
F	BILL NO. 6: INSTALLATION OF PLASTIC TANK ON MILD STEEL PLATFORM AND LAYING MAIN PIPE		
G	BILL NO. 7: FENCING BOREHOLE SITE (1000 SM)		
H	BILL NO. 8: CONSTRUCTION OF CATTLE TROUGH		
	TOTAL CARRIED TO GRAND SUMMARY		

ITEM NO.	ITEM DESCRIPTION	UNIT	QTY	RATE (KSHS)	AMOUNT KSHS
	BILL NO.01 PRELIMINARIES AND GENERALS				
A	Allow provision for insurance in accordance with Clauses 21, 23 and 24 of the Conditions of Contract II for Drilling	ITEM	1		
B	Allow provision for power and water supply	ITEM	1		
C	Mobilization, transportation of machinery, erection of camps and sanitary facilities and demobilization	LS	1		
D	Provide sign board for the work as required by law	ITEM	1		
TOTAL (CARRIED TO SUMMARY)					

ITEM	DESCRIPTION	UNIT	QTY	RATE KSHS	AMOUNT KSHS	C T S
	BILL NO. 2 PROVISIONAL SUMS					
	The tender shall include in his/her tender the following Provisional Sums to be expended in whole or part thereof at the discretion and on instructions of the Project Manager.					
A.	Allow a Provisional sum of Kenya Shillings seven hundred thousand (Kshs. 700,000/=) for Project Supervision and Administrative expenses.	PS	1	700,000	700,000	00

B	Allow a provisional sum of Kenya shillings one million, two hundred thousand (Ksh 1,200,000) for access road to site, design review of solar pumping unit and auxiliary facilities to be expended in whole or part as instructed by the PM	LS	1	1,200,000	1,200,000	00
C	Allow for provisional sum of Ksh 500,000.00 for water reticulation.	LS	1	500,000	500,000	00
D	Allow for attendance for A,B and C	%				
	TOTAL CARRIED TO SUMMARY					

Item	DESCRIPTION	UNIT	QTY	RATE	AMOUNT
				(KSHS)	KSHS
	BILL No. 3: DRILLING, DEVELOPMENT and TEST PUMPING TOTAL DEPTH: 250M				
A	Erecting and dismantling of drilling equipment and other machinery at the site.	LS	1		
B	Drilling of borehole of minimum diameter 205mm through all types of strata including disposal of excavated materials, taking any remedial measures to overcome caving-in, or over drilling to accommodate sloughed material and keeping drilling records as specified between ground level and 250 metres below ground level.				
C	Drilling from 0 - 10m depth	M	10		

D	Drilling from 10 -100m depth	M	90		
E	Drilling from 100 - 200m depth	M	100		
F	Drilling beyond 200m depth	M	50		
G	Supply and install 152 mm internal diameter plain steel casings in the borehole.	M	200		
H	Ditto A1.5 but 152mm internal diameter slotted steel casings.	M	50		
I	Allow for taking samples of drill cuttings at two (2) metres intervals	LS	1		
J	Supply and insert gravel pack (rounded 2-4 mm diameter).	Tons	10		
K	Grout between the casing and the borehole for top ten (10) metres.	LS	1		
L	Physical development of the borehole including inserting and removal of development equipment;	HR	3		
M	Chemical development of the borehole including inserting and removal of development equipment;	HR	3		
N	Undertake Constant Discharge Test as specified (24 hours for actual test pumping and 8 hours for insertion and removal of test pumping equipment)	HR	32		
O	Undertake water Level observation and record recovery.	HR	8		
P	Carry out borehole sterilization	LS	1		

Q	Install wellhead, well cap serial number and borehole chamber of dimensions 1.0x1.0x1.0 metres with a heavy gauge borehole chamber cover around the wellhead as shall be approved by the PM	LS	1		
R	Supply of drilling fluids for drilling operations and field camp	LS	1		
S	Take water samples for laboratory analysis (1 No. sample for Bacteriological and 1 No. for Chemical each 15 litres).	LS	1		
T	Allow for making good and surface reinstatement at the borehole location to the Project Manager's satisfaction.	LS	1		
TOTAL CARRIED TO SUMMARY					

ITEM	DESCRIPTION	UNIT	QTY	AMOUNT		
				KSHS	KSHS	CTS
	BILL NO.04: SUPPLY AND INSTALLATION OF GRUNDFOS SOLAR PUMP-Assumed Head =260m (PUMP TYPE SP5A-33 with DISCHARGE of 3.5M3/hr Powered by3KW motor and nine (24) Solar PANNELS with 250W capacity)					
A	Supply, deliver to site and install Submersible Pump, SP5A-33 or its approved equivalent.	UNIT	1			

B	Supply, delivery of Monocrystalline Photo Voltaic Solar Modules connected in Panels of 250W, 12Vdc	UNIT	24			
C	Erect an appropriate stand for the panels made of 75mm stand pipes, 50 mm SHS members to support the panels, guard rails, permanent and movable ladders as shall be approved by the PM	ITEM	1			
D	Supply, deliver to site and install Submersible Pump control panel for SP3A-45 or its approved equivalent, 3-Phase, 415Vac, 50Hz DOL	UNIT	1			
E	Supply, deliver to site and install matching solar disconnect switch.	UNIT	1			
F	Submersible cable- 4.0mm ² /4-core flexible tough rubber	M	310			
G	UG Cable- 4.0mm ² /4-core	M	20			
H	Electrode Cable- 1 mm ² (Red and Black)	M	310			
I	Supply, deliver to site and install Submersible PVC pipes 40mm diameter	M	236			
J	Supply, deliver to site and install DN65 uPVC Class B Water pipes	M	260			
K	Supply, deliver to site and install PN6xDN65 GS non-return valve (threaded)	No.	1			
L	Supply, deliver to site and install PN6xDN65 gate valve (Female threaded Pegler)	No.	1			
M	Supply, deliver to site and install and test 1.2m metre copper Earth electrode	No.	1			
N	Supply, deliver to site, install and test D6 x 120mm stainless steel Electrodes	No.	2			
O	Install Earth electrode wire, 6.0mm ² Copper cable (Green)	M	10			
P	Supply and Install GS Cable termination box of size 150mmx150mmx100mm depth with 35 amps, 2-way plastic cable connector terminal blocks	No.	1			
Q	Supply, deliver to site and install lockable 2 flap steel top covers 2.0mm thickness to fit Borehole protection Chamber	No.	1			

R	Supply, deliver to site and install DN65 Water metre, (threaded), type ABB, Range 0 – 20 m ³ /hour	No.	1			
S	Supply, deliver to site and install Borehole Steel Pipe Clamp of thickness 5.0mm with holes for smooth passage of DN65 GI, DN20 uPVC pipes, 2x1.0 mm ² and 10.0 mm ² /4-core	No.	1			
T	Supply, deliver to site, install and test pressure gauge, approved type as Kent, Range 0 – 15.0 kg/cm ²	No.	1			
U	Supply, deliver to site and install RC cable route markers	No.	1			
V	Supply, deliver to site and use Borehole sundries	ITEM	1			
W	Carry out electrical earth bonding and wiring connections and connect to the earth led as directed by the Engineer.	ITEM	1			
	TOTAL BILLNO.04 CARRIED TO SUMMARY					

ITEM	DESCRIPTION	UNIT	QTY	RATE KSHS	AMOUNT	
					KSHS	CTS
	BILL NO.5: CONSTRUCTION OF WATER KIOSK WITH REINFORCED PLATFORM FOR TANK AND SOLAR MODULE					
	A. <u>SUBSTRUCTURES</u>					
	ELEMENT NO. 01- SUBSTRUCTURE					
	<u>(ALL PROVISIONAL)</u>					
A	Excavate oversite to remove vegetable soil average 150mm deep;wheel and deposit on site n.e. 100M away in permanent spoils heaps	SM	12			
B	Ditto but to a depth of 300mm	CM	1.8			
C	Excavate for pad foundation and strip footing not exceeding 1000 mm deep.	CM	25			
	<u>Disposal</u>					
D	Cart away excess excavated material to spoil	CM	10			

	<u>Hardcore</u>				
E	250mm thick filling: deposit, spread, level and compact: to receive blinding	CM	3		
F	50mm murrum blinding to surface of hardcore.	SM	6		
	<u>Anti-Termite Treatment</u>				
G	Chemical anti-termite treatment executed by Rentokil Laboratoties Limited or equal and approved pest control firm under a ten-year gurantee, applied to surface of excavation and floor	SM	12		
	<u>Damp-Proof Membrane</u>				
H	500mm Gauge polythene damp-proof membrane laid on blinded hardcore with 100mm folded side and end laps (measured net-allow for laps)	SM	12		
	<u>Plain Concrete 1:4:8 mix in:</u>				
G	50 mm blinding bed under strip footing	CM	6		
	<u>Reinforced Concrete 1:2:4- 20mm gauge mix in</u>				
H	150 mm floor slab	SM	12		
I	300 mm thick Strip Footing	CM	2.16		
J	600 x150mm thick pavement round the perimeter walling	SM	1.08		
	<u>Reinforcement</u>				
	<u>High Tensile Steel Reinforcement to B.S. 4483</u>				
K	Y12	NO	6		
L	Y10	NO	4		
M	Y8	NO	4		
	<u>Mesh Fabric Reinforcement to B.S.4483</u>				
N	Mesh reinforcement reference A 142 weighing 2.22kg per square metre laid in bed with 300mm side and end laps (Measured net allow for laps)	SM	17		
	<u>MASONRY</u>				

O	<u>Medium quarry dressed stone walling in cement and sand (1:3) mortar:20 gauge x 25mm wide hoop iron reinforcement and column-wall ties in every alternate course: to</u>					
P	<u>200mm walling in Foundation</u>	SM	15			
	<u>Hessian Based Bituminous Felt Damp-Proof course to B.S.743 type 4A and setting in cement and sand mortar</u>					
Q	<u>under 200mm walls</u>	L.M	10			
	TOTAL ELEMENT 01					
	DESCRIPTION	UNIT	QTY	RATE	AMOUNT	
ITEM				KSHS	KSHS	CTS
	<u>ELEMENT NO-02</u>					
	<u>CONCRETE WORK AND WALLING</u>					
	-					
	<u>Reinforced Concrete 1:2:4- 20mm gauge mix in</u>					
A	Rings Beams;450x200	CM	0.9			
B	150mm roof slab and fetching bay	CM	1.8			
	<u>Sawn formwork to</u>					
C	sides and soffits of beams	SM	9.7			
D	Ditto but to sides and of columns	SM	19.2			
E	Ditto but including props beneath the roof slab and fetching bay	SM	12			
	<u>Reinforcement</u>					
	<u>High Tensile Steel for columns, ring beam and top slab Reinforcement to B.S. 4483</u>					
F	Y16mm Bars	NO	12			
G	Y10mm Bars	NO	16			
H	Y12mm Bars	NO	15			
	<u>Walling</u>					
	<u>Medium quarry dressed stone walling in cement and sand (1:3)mortar:20 gauge x 25mm wide hoop iron reinforcement and column-wall ties in every alternate course: to</u>					

I	200mm walling	SM	25			
	TOTAL ELEMENT 02					
		UNIT	QTY	RATE	AMOUNT	
ITEM	DESCRIPTION			KSHS	KSHS	CTS
	<u>ELEMENT NO-03</u>					
	<u>DISPOSAL</u>					
A	Plastic downpipes;75mm diameter	L.M	6			
B	10,000 litres Plastic Kentank or equivalent and approved by RE	No	1			
	TOTAL ELEMENT 03					
		UNIT	QTY	RATE	AMOUNT	
ITEM	DESCRIPTION			KSHS	KSHS	CTS
	ELEMENT NO. 04					
	<u>FINISHINGS</u>					
	<u>Cement and Sand (1:4) Screed and Paving</u>					
	<u>FLOOR FINISHES</u>					
	<u>Cement and sand (1:4) paving: steel trowelled: on concrete</u>					
A	40mm thick floors to receive tiles	SM	10			
B	Tiling on the floor including water fetching area up to the bay deck as approved by RE	SM	20			
	<u>12mm Two Coats Lime Plaster with steel Trowel Finished to:</u>					
C	Internal walls and slab soffit	SM	35			
D	External walls including keying	SM	10			
	TOTAL ELEMENT 04					
		UNIT	QTY	RATE	AMOUNT	
ITEM	DESCRIPTION			KSHS	KSHS	CTS
	ELEMENT NO. 5					
	DOORS					
	<u>Steel Door</u>					

A	Standard single leaf steel door to the satisfaction of the RE	NO.	1			
	TOTAL ELEMENT 05					
		UNIT	QTY	RATE	AMOUNT	
ITEM	DESCRIPTION			KSHS	KSHS	CTS
	ELEMENT NO.6					
	WINDOWS					
A	2000x1200mm double leaf steel window as directed by RE	NO	1			
	TOTAL ELEMENT 06					
		UNIT	QTY	RATE	AMOUNT	
ITEM	DESCRIPTION			KSHS	KSHS	CTS
	ELEMENT NO.07					
	-					
	<u>PAINTING AND DECORATING</u>					
	<u>Prepare and apply three coats plastic emulsion paint to:</u>					
	<u>Internally</u>					
A.	Plastered walls	SM	45			
	-					
B	Ditto but to the doors and window surfaces as Directed by RE	SM	10			
	TOTAL ELEMENT 07					
ITEM	DESCRIPTION	UNIT	QTY	RATE	AMOUNT	
	ELEMENT NO.08			KSHS		
	PLUMBING WORKS				KSHS	CTS
A	32mm thick floors screed	SM	11.6			
	Plumbing (Supply and fix the following)					
B	¾" GI pipe	No.	1			
C	¾" Gate Valve (Peggler)	No.	1			
D	¾" Bend	No.	3			

E	¾" Elbow	No.	4			
F	¾ Tee equal	No.	3			
G	¾" Union	No.	1			
H	¾ "Stop Cork (Pegglar)	No.	3			
I	¾" Hexagonal nipple	No.	10			
J	¾" Sockets	No.	2			
K	PVC end-caps 2"	No.	2			
L	PVC end-caps 1½"	No.	2			
M	PVC Tee equal 2"	No.	2			
N	Ditto ½"	No.	2			
O	Reducing socket 2" x ¾" PVC	No.	2			
P	Ditto 1 ½" x ¾"	No.	2			
Q	PVC Adapter ¾"	No.	2			
	TOTAL ELEMENT 08					
	SUMMARY				AMOUNT	
	ELEMENT NO.				KSHS	CTS
	1. SUBSTRUCTURE					
	2. CONCRETE WORK AND WALLING					
	3. ROOFING AND RAINWATER DISPOSAL					
	4. FINISHING					
	5. DOORS					
	6. WIDOWS					
	7. PAINTING AND DECORATION					
	8. PLUMBING WORKS					
	SUB TOTAL					
	GRAND TOTAL					

	Bill No.06 -STEEL TOWER 3M HIGH FOR 10,000 LITRES PLASTIC TANK					
		CONTRACT VALUES				
ITEM	DESCRIPTION	UNIT	QUANTITY	RATE	AMOUNT (KShs)	
					Kshs	CTS
	<u>A.SUBSTRUCTURES</u>					
	(ALL PROVISIONAL)					
1.1	<u>Excavation,including maintaining and supporting sidesand keepings bottom free from water and mud or other fallen materials</u>					
1.1.1	Excavate oversite to remove vegetable soil average 150mm deep;wheel and deposit on site n.e. 100M away in permanent spoils heaps	m2	9			
1.1.2	Excavate for Columns footing not exceeding 1.50m deep,from formation level	m3	12			
1.1.3	Ditto on soft rock depth n.e 1.5m	m3	6			
	Filling & disposal					
1.1.4	Back filling selected excavated materials around foundation.	m3	8			

	Plain Concrete 1:4:8 mix in:					
1.1.5	50 mm blinding bed under columns bases footing	m3	0.5			
	Reinforced Concrete 1:1.5:3-25mm gauge mix in					
1.1.6	Columns bases 1200x1200x350	m3	2.1			
1.1.7	Stub columns	m3	0.6			
	Sawn formwork to					
1.1.8	sides and soffits of columns bases	m2	7			
1.1.9	Ditto but to sides of columns	m2	8			
	Reinforcement					
	High Tensile Steel for columns, ring beam and top slab Reinforcement to B.S. 4483					
1.1.10	T8mm Bars	kgs	17			
1.1.11	T12mm Bars	kgs	120			

	SUB-TOTAL Sub-structure CARRIED FORWARD					
	ELEMENT NO-02					
2.1	<u>B. SUPERSTRUCTURES</u>					
	Steel Works-Mild steel to BS 449					
	Provide, fabricated and fix by welding to position and painting steel members at site as per the drawings the following steel elements as directed by RE					
2.1.2	75x75x4mm Square hollow sections columns tubes frames	m	12			
2.1.3	100x50x4mm Rectangular hollow sections	m	32			
2.1.4	150x100x4mm Rectangular hollow sections frames	m	6			
2.1.5	40x40x2mm Square hollow sections	m	72			
2.1.6	50x50x4mm angle line sections	m	36			
2.1.7	2400x1200x4mm chequered plate	No	4			
2.1.8	10mm thick,2400x1200mm plates	No	1			
2.1.9	Paint work finishes to steel members	Item	1			

	SUB-TOTAL ELEMENT NO-02 CARRIED FORWARD					
	ELEMENT NO-03					
3.1	<u>PLUMBING WORKS</u>					
3.1.2	Supply and fix all pipes,joints and collection tabs	item	1			
3.1.3	10,000 litres Plastic roto or equivalent and approved by PM	no	1			
	SUB-TOTAL ELEMENT NO-03 CARRIED FORWARD					
	SUMMARY					
		CONTRACT VALUES				
ITEM	DESCRIPTION	UNIT	QUANTITY	RATE	AMOUNT (KShs)	
					Kshs	CTS
	-					

1.1	SUB-TOTAL Sub-structure CARRIED FORWARD					
1.2	SUB-TOTAL ELEMENT NO- 02 CARRIED FORWARD					
1.3	SUB-TOTAL ELEMENT NO- 03 CARRIED FORWARD					
	GRAND SUMMARY FOR ELEVATED TANK					

ITEM	DESCRIPTION	UNIT	QTY	RATE KSHS	AMOUNT
					KSHS
	BILL NO.07				
	FENCING BOREHOLE SITE (1000 SM)				
	<u>(ALL PROVISIONAL)</u>				
A.	Clearing the site of bushes/trees	SM	1000		
B	Excavate for fencing poles bases from existing ground level and not exceeding 1.50m deep. (225 x 225x500mm deep holes)	NO.	45		
	<u>Concrete Work</u>				

	<u>Mass concrete 1:4: 8-</u>				
C	50 mm blinding bed under holes for fencing posts	CM	0.2		
	<u>Reinforced Concrete 1:2:4- 20mm gauge mix in</u>				
D	225x225x450 Bases for Angle columns sections	CM	1.5		
	<u>MILD STEEL TO B.S. 449</u>				
	<u>Structural steel welded & Bolted joints</u>				
E	50x50x3 mm Angle column section (Length 2350mm spaced at 3 m c/c)	NO	48		
G	50x50x3 mm angle section for bracing at corners and at every 30m span (Length 3600mm)	NO	12		
	<u>GATE</u>				
K	Excavate for sides columns poles bases from existing ground level and not exceeding 1.50m deep. (225 x 225x500mm deep holes)	NO.	4		
	<u>Concrete Work</u>				
	<u>Mass concrete 1:4: 8-</u>				
M	50 mm blinding bed under holes for fencing posts	CM	0.1		
N	<u>Reinforced Concrete 1:2:4- 20mm gauge mix in</u>				
	225x225x450 Bases for SHS columns	CM	0.1		
	<u>MILD STEEL TO B.S. 449</u>				

	Structural steel welded & Bolted joints				
O	75x75x4.0mm SHS column (Length 2000mm)	NO.	3		
P	50x50x3.0mm SHS	LM	28.5		
Q	50x50x3.0mm SHS	LM	21		
	<u>FENCING WIRE</u>				
	High tension wire				
R	4,5mm high tension wire 6 strands or as it shall be approved by the PM	M	780		
	<u>Chain Link</u>				
S	Fence with 3mm chain link (80mmx80mm)	SM	234		
	Devki binding wire roll; or equivalent	NO.	1		
	TOTAL BILL NO .06: CARRIED TO SUMMARY				

ITEM	DESCRIPTION	UNIT	QTY	RATE (KSHS)	AMOUNT	
					KSHS	CTS
	BILL NO.08					
	CATTLE TROUGH					
	SUBSTRUCTURES					
	<u>(ALL PROVISIONAL)</u>					

A	Excavate oversite to remove vegetable soil average 150mm deep; wheel and deposit on site n.e. 100M away in permanent spoils heaps	SM	72.1			
	<u>Hardcore</u>					
D	250mm thick filling: deposit, spread, level and compact: to receive blinding	SM	72.1			
E	50mm murrum blinding to surface of hardcore.	SM	72.1			
	<u>Anti-Termite Treatment</u>					
F	Chemical anti-termite treatment executed by Rentokil Laboratoties Limited or equal and approved pest control firm under a ten year gurantee, applied to surface of excavation and floor	SM	72.1			
	<u>Damp-Proof Membrane</u>					
G	500mm Gauge polythene damp-proof membrane laid on blinded hardcore with 100mm folded side and end laps (measured net-allow for laps)	SM	72.1			
	<u>Reinforced Concrete 1:2:4- 20mm</u>					
H	150 mm floor slab	CM	10.8			
I	150 mm thick Rc Walls	CM	3.85			

	<u>Reinforcement</u>					
	<u>High Tensile Steel Reinforcement to B.S. 4483</u>					
	<u>Mesh Fabric Reinforcement to B.S.4483</u>					
J	Mesh reinforcement reference A 142 weighing 2.22kg per square metre laid in bed with 300mm side and end laps (Measured net allow for laps)	SM	160			
	<u>PLUMBING</u>					
K	Supply and fit 32mm gate valve and connect to supply main	NO	1			
L	Supply and fit Ball Valve	NO	1			
	<u>STEEL COVER</u>					
M	Access cover	NO	1			
	<u>TOTAL CARRIED TO SUMMARY</u>					

Schedule of Adjustment Data

Table A - Local Currency

Index Code	Index Description	Source of Index	Base Value and Date	Bidder's Local Currency Amount	Bidder's Proposed Weighting
	Nonadjustable	—	—	—	A: _____ B: _____ C: _____ D: _____ E: _____
Total					1.00

Table B - Foreign Currency

Name of Currency: _____

If the Bidder wishes to quote in more than one foreign currency, this table should be repeated for each foreign currency.

Index Code	Index Description	Source of Index	Base Value and Date	Bidder's Currency in Type/Amount	Equivalent in FC1	Bidder's Proposed Weighting
	Nonadjustable	—	—	—		A: _____ B: _____ C: _____ D: _____ E: _____
Total						1.00

Summary of Payment Currencies

Table: Alternative A

Forinsert name of Section of the Works

Separate tables may be required if the various sections of the Works (or of the Bill of Quantities) will have substantially different foreign and local currency requirements. The Employer should insert the names of each Section of the Works.

	A	B	C	D
Name of Payment Currency	Amount of Currency	Rate of Exchange to Local Currency	Local Currency Equivalent $C = A \times B$	Percentage of Net Bid Price (NBP) $\frac{100 \times C}{NBP}$
Local currency _____		1.00		
Foreign Currency #1 _____				
Foreign Currency #2 _____				
Foreign Currency #3 _____				
Net Bid Price				100.00
Provisional Sums Expressed in Local Currency		1.00		
BID PRICE				

Table: Alternative B

To be used only with Alternative B Prices directly quoted in the currencies of payment.
(Clause **ITB** 15.1)

Summary of currencies of the bid for _____ [insert name of Section of the Works]

Name of currency	Amounts payable
Local currency: _____	
Foreign currency #1: _____	
Foreign currency #2: _____	
Foreign currency #3: _____	

<h2 style="text-align: center;">Form of Bid Security (Bank Guarantee)</h2>
--

_____ [Bank's Name, and Address of Issuing Branch or Office]

Beneficiary: _____ [Name and Address of Employer]

Date: _____

BID GUARANTEE No.: _____

We have been informed that _____ [name of the Bidder] (hereinafter called "the Bidder") has submitted to you its bid dated _____ (hereinafter called "the Bid") for the execution of _____ [name of contract] under Invitation for Bids No. _____ ("the IFB").

Furthermore, we understand that, according to your conditions, bids must be supported by a bid guarantee.

At the request of the Employer, we _____ [name of Bank] hereby irrevocably undertake to pay you any sum or sums not exceeding in total an amount of _____ [amount in figures] (_____) [amount in words] upon receipt by us of your first demand in writing accompanied by a written statement stating that the Bidder is in breach of its obligation(s) under the bid conditions, because the Bidder:

- (a) has withdrawn its Bid during the period of bid validity specified by the Bidder in the Form of Bid; or
- (b) having been notified of the acceptance of its Bid by the Employer during the period of bid validity, (i) fails or refuses to execute the Contract Form, if required, or (ii) fails or refuses to furnish the performance security, in accordance with **ITB 38**.

This guarantee will expire: (a) if the Bidder is the successful Bidder, upon our receipt of copies of the contract signed by the Bidder and the performance security issued to you upon the instruction of the Bidder; and (b) if the Bidder is not the successful Bidder, upon the earlier of (i) our receipt of a copy your notification to the Bidder of the name of the successful Bidder; or (ii) twenty-eight days after the expiration of the Bidder's bid.

Consequently, any demand for payment under this guarantee must be received by us at the office on or before that date.

This guarantee is subject to the Uniform Rules for Demand Guarantees, ICC Publication No. 458.

[signature(s)]

Form of Bid Security (Bid Bond)

BOND NO. _____

BY THIS BOND [name of Bidder] as Principal (hereinafter called “the Principal”), and [name, legal title, and address of surety], **authorized to transact business in** [name of country of Employer], as Surety (hereinafter called “the Surety”), are held and firmly bound unto [name of Employer] as Obligee (hereinafter called “the Employer”) in the sum of [amount of Bond]¹⁵ [amount in words], for the payment of which sum, well and truly to be made, we, the said Principal and Surety, bind ourselves, our successors and assigns, jointly and severally, firmly by these presents.

WHEREAS the Principal has submitted a written Bid to the Employer dated the ___ day of _____, 20___, for the construction of [name of Contract] (hereinafter called the “Bid”).

NOW, THEREFORE, THE CONDITION OF THIS OBLIGATION is such that if the Principal:

- (a) withdraws its Bid during the period of bid validity specified in the Form of Bid; or
- (b) having been notified of the acceptance of its Bid by the Employer during the period of Bid validity; (i) fails or refuses to execute the Contract Form, if required; or (ii) fails or refuses to furnish the Performance Security in accordance with the Instructions to Bidders;

then the Surety undertakes to immediately pay to the Employer up to the above amount upon receipt of the Employer’s first written demand, without the Employer having to substantiate its demand, provided that in its demand the Employer shall state that the demand arises from the occurrence of any of the above events, specifying which event(s) has occurred.

The Surety hereby agrees that its obligation will remain in full force and effect up to and including the date 28 days after the date of expiration of the Bid validity as stated in the Invitation to Bid or extended by the Employer at any time prior to this date, notice of which extension(s) to the Surety being hereby waived.

IN TESTIMONY WHEREOF, the Principal and the Surety have caused these presents to be executed in their respective names this ___ day of _____ 20___.

Principal: _____

Surety: _____
Corporate Seal (where appropriate)

¹⁵ The amount of the Bond shall be denominated in the currency of the Employer’s country or the equivalent amount in a freely convertible currency.

(Signature)

(Signature)

(Printed name and title)

(Printed name and title)

Form of Bid-Securing Declaration

Date: [insert date (as day, month and year)]

Bid No.: [insert number of bidding process]

Alternative No.: [insert identification No if this is a Bid for an alternative]

To: [insert complete name of Employer]

We, the undersigned, declare that:

We understand that, according to your conditions, bids must be supported by a Bid-Securing Declaration.

We accept that we will automatically be suspended from being eligible for bidding in any contract with the Borrower for the period of time of **[Employer to insert number of months or years]** starting on **[insert date]**, if we are in breach of our obligation(s) under the bid conditions, because we:

- (a) have withdrawn our Bid during the period of bid validity specified in the Letter of Bid; or
- (b) having been notified of the acceptance of our Bid by the Employer during the period of bid validity, (i) fail or refuse to execute the Contract, if required, or (ii) fail or refuse to furnish the Performance Security, in accordance with **ITB 38**.

We understand this Bid-Securing Declaration shall expire if we are not the successful Bidder, upon the earlier of (i) our receipt of your notification to us of the name of the successful Bidder; or (ii) twenty-eight days after the expiration of our Bid.

Signed: [insert signature of person whose name and capacity are shown] In the capacity of [insert legal capacity of person signing the Bid-Securing Declaration]

Name: [insert complete name of person signing the Bid-Securing Declaration]

Duly authorized to sign the bid for and on behalf of: [insert complete name of Bidder]

Dated on _____ day of _____, _____ [insert date of signing]

Corporate Seal (where appropriate)

[Note: In case of a Joint Venture, the Bid-Securing Declaration must be in the name of all partners to the Joint Venture that submits the bid.]

<h2>Technical Proposal</h2>

Technical Proposal Forms

Site Organization

Method Statement

Mobilization Schedule

Construction Schedule

Contractor's Equipment

Personnel

Others

<p style="text-align: center;">Site Organization</p>

<p>Method Statement</p>

<p>Mobilization Schedule</p>

Construction Schedule

Contractor's Equipment

Form EQU

The Bidder shall provide adequate information to demonstrate clearly that it has the capability to meet the requirements for the key equipment listed in Section III, Evaluation and Qualification Criteria. A separate Form shall be prepared for each item of equipment listed, or for alternative equipment proposed by the Bidder. The Bidder shall provide all the information requested below, to the extent possible. Fields with asterisk (*) shall be used for evaluation.

Type of Equipment*	
Equipment Information	Name of manufacturer
	Model and power rating
	Capacity*
	Year of manufacture*
Current Status	Current location
	Details of current commitments
Source	Indicate source of the equipment <input type="checkbox"/> Owned <input type="checkbox"/> Rented <input type="checkbox"/> Leased <input type="checkbox"/> Specially manufactured

The following information shall be provided only for equipment not owned by the Bidder.

Owner	Name of owner	
	Address of owner	
	Telephone	Contact name and title
	Fax	Telex
Agreements	Details of rental / lease / manufacture agreements specific to the project	

Proposed Personnel

Form PER – 1

Bidders should provide the names of suitably qualified personnel to meet the specified requirements for each of the positions listed in Section III, Evaluation and Qualification Criteria. The data on their experience should be supplied using the Form below for each candidate.

1.	Title of position
	Name
2.	Title of position
	Name
3.	Title of position
	Name
4.	Title of position
	Name
5.	Title of position
	Name
6.	Title of position
	Name
etc.	Title of position
	Name

<p>Others</p>

Bidder's Qualification

To establish its qualifications to perform the contract in accordance with Section III, Evaluation and Qualification Criteria, the Bidder shall provide the information requested in the corresponding Information Sheets included hereunder.

Bidder Information Sheet

Form ELI - 1.1

Date: _____

Bidding No.: _____

Invitation for Bid No.: _____

Page _____ of _____ pages

1. Bidder's Legal Name
2. In case of Joint Venture, Consortium or Association (JVCA), legal name of each party:
3. Bidder's actual or intended Country of Registration:
4. Bidder's Year of Registration:
5. Bidder's Legal Address in Country of Registration:
6. Bidder's Authorized Representative Information Name: Address: Telephone/Fax numbers: Email Address:
7. Attached are copies of original documents of: <ul style="list-style-type: none"> <input type="checkbox"/> Articles of Incorporation or Registration of firm named in 1, above, in accordance with ITB Clauses 4.1 and 4.2. <input type="checkbox"/> In case of JVCA, letter of intent to form JVCA including a draft agreement, or JVCA agreement, in accordance with ITB Clause 4.1 <input type="checkbox"/> In case of government owned entity from the Employer's country, documents establishing legal and financial autonomy and compliance with the principles of commercial law, in accordance with ITB Clause 4.5.

<h2 style="margin: 0;">Party to JVCA Information Sheet</h2>

Form ELI - 1.2

Date: _____
 Bidding No.: _____
 Invitation for Bid No.: _____
 Page _____ of _____ pages

1. Bidder's Legal Name:
2. JVCA's Party legal name:
3. JVCA's Party Country of Registration:
4. JVCA's Party Year of Registration:
5. JVCA's Party Legal Address in Country of Registration:
6. JVCA's Party Authorized Representative Information Name: Address: Telephone/Fax numbers: Email Address:
7. Attached are copies of original documents of: <ul style="list-style-type: none"> <input type="checkbox"/> Articles of Incorporation or Registration of firm named in 1, above, in accordance with ITB Clauses 4.1 and 4.2. <input type="checkbox"/> In case of government owned entity from the Purchaser's country, documents establishing legal and financial autonomy and compliance with the principles of commercial law, in accordance with ITB Clause 4.5.

Historical Contract Non-Performance

Form CON – 2

Bidder's Legal Name: _____

Date: _____

JVCA Partner Legal Name: _____

Bidding No.: _____

Page _____ of _____ pages

Non-Performing Contracts in accordance with (Evaluation and Qualification Criteria)			
<input type="checkbox"/> Contract non-performance did not occur during the stipulated period, in accordance with Sub-Factor 2.2.1 of Section III, Evaluation and Qualification Criteria.			
<input type="checkbox"/> Contract non-performance during the stipulated period, in accordance with Sub-Factor 2.2.1 of Section III, Evaluation and Qualification Criteria.			
Year	Outcome as Percent of Total Assets	Contract Identification	Total Contract Amount (current value, US\$ equivalent)
_____	_____	Contract Identification: Name of Employer: Address of Employer: Matter in dispute:	_____
Pending Litigation, in accordance with Section III, Evaluation and Qualification Criteria			
<input type="checkbox"/> No pending litigation in accordance with Sub-Factor 2.2.3 of Section III, Evaluation and Qualification Criteria.			
<input type="checkbox"/> Pending litigation in accordance with Sub-Factor 2.2.3 of Section III, Evaluation and Qualification Criteria, as indicated below			
Year	Outcome as Percent of Total Assets	Contract Identification	Total Contract Amount (current value, US\$ equivalent)
_____	_____	Contract Identification: Name of Employer: Address of Employer: Matter in dispute:	_____
_____	_____	Contract Identification: Name of Employer: Address of Employer: Matter in dispute:	_____

Current Contract Commitments / Works in Progress

Form CCC

Bidders and each partner to a JVCA should provide information on their current commitments on all contracts that have been awarded, or for which a letter of intent or acceptance has been received, or for contracts approaching completion, but for which an unqualified, full completion certificate has yet to be issued.

Name of contract	Employer, contact address/tel/fax	Value of outstanding work (current US\$ equivalent)	Estimated completion date	Average monthly invoicing over last six months (US\$/month)
1.				
2.				
3.				
4.				
5.				
etc.				

Financial Situation

Form FIN – 3.1

Historical Financial Performance

Bidder’s Legal Name: _____ Date: _____

JVCA Partner Legal Name: _____ Bidding No.: _____

Page _____ of _____ pages

To be completed by the Bidder and, if JVCA, by each partner

Financial information in US\$ equivalent	Historic information for previous _____ (____) years (US\$ equivalent in 000s)						
	Year 1	Year 2	Year 3	Year ...	Year n	Avg.	Avg. Ratio
Information from Balance Sheet							
Total Assets (TA)							
Total Liabilities (TL)							
Net Worth (NW)							
Current Assets (CA)							
Current Liabilities (CL)							
Information from Income Statement							
Total Revenue (TR)							
Profits Before Taxes (PBT)							

- Attached are copies of financial statements (balance sheets, including all related notes, and income statements) for the years required above complying with the following conditions:
 - Must reflect the financial situation of the Bidder or partner to a JVCA, and not sister or parent companies
 - Historic financial statements must be audited by a certified accountant
 - Historic financial statements must be complete, including all notes to the financial statements
 - Historic financial statements must correspond to accounting periods already completed and audited (no statements for partial periods shall be requested or accepted)

Average Annual Turnover

Form FIN – 3.2

Bidder’s Legal Name: _____ Date: _____
 JVCA Partner Legal Name: _____ Bidding No.: _____
 Page _____ of _____ pages

Annual turnover data (construction only)		
Year	Amount and Currency	US\$ equivalent
	_____	_____
	_____	_____
	_____	_____
	_____	_____
	_____	_____
	_____	_____
*Average Annual Construction Turnover	_____	_____

*Average annual turnover calculated as total certified payments received for work in progress or completed over the number of years specified in Section III, Evaluation and Qualification Criteria, Sub-Factor 2.3.2, divided by that same number of years.

Financial Resources

Form FIN – 3.3

Specify proposed sources of financing, such as liquid assets, unencumbered real assets, lines of credit, and other financial means, net of current commitments, available to meet the total construction cash flow demands of the subject contract or contracts as indicated in Section III, Evaluation and Qualification Criteria.

Source of financing	Amount (US\$ equivalent)
1.	
2.	
3.	
4.	

General Experience

Form EXP – 2.4.1

Bidder's Legal Name: _____ Date: _____
 JVCA Partner Legal Name: _____ Bidding No.: _____
 Page _____ of _____ pages

Starting Month / Year	Ending Month / Year	Years*	Contract Identification	Role of Bidder
_____	_____		Contract name: Brief Description of the Works performed by the Bidder: Name of Employer: Address:	_____
_____	_____		Contract name: Brief Description of the Works performed by the Bidder: Name of Employer: Address:	_____
_____	_____		Contract name: Brief Description of the Works performed by the Bidder: Name of Employer: Address:	_____
_____	_____		Contract name: Brief Description of the Works performed by the Bidder: Name of Employer: Address:	_____
_____	_____		Contract name: Brief Description of the Works performed by the Bidder: Name of Employer: Address:	_____
_____	_____		Contract name: Brief Description of the Works performed by the Bidder: Name of Employer: Address:	_____

*List calendar year for years with contracts with at least nine (9) months activity per year starting with the earliest year

Specific Experience

Form EXP – 2.4.2(a)

Bidder's Legal Name: _____ Date: _____
 JVCA Partner Legal Name: _____ Bidding No.: _____
 Page _____ of _____ pages

Similar Contract Number: ___ [insert specific number] of ___ [insert total number of contracts required].	Information		
Contract Identification	_____		
Award date	_____		
Completion date	_____		
Role in Contract	<input type="checkbox"/> Contractor	<input type="checkbox"/> Management Contractor	<input type="checkbox"/> Subcontractor
Total contract amount	_____		US\$ _____
	—		—
If partner in a JVCA or subcontractor, specify participation of total contract amount	_____ %	_____	US\$ _____
Employer's Name:	_____		
Address:	_____ _____		
Telephone/fax number:	_____		
E-mail:	_____		

Specific Experience (cont.)

Form EXP – 2.4.2(a) (cont.)

Bidder’s Legal Name: _____ Page _____ of _____ pages
 JVCA Partner Legal Name: _____

Similar Contract No. __[insert specific number] of __[insert total number of contracts] required	Information
Description of the similarity in accordance with Sub-Factor 2.4.2(a) of Section III, Evaluation and Qualification Criteria:	
Amount	_____
Physical size	_____
Complexity	_____
Methods/Technology	_____
Physical Production Rate	_____

Specific Experience in Key Activities

Form EXP – 2.4.2(b)

Bidder's Legal Name: _____ Date: _____
 JVCA Partner Legal Name: _____ Bidding No.: _____
 Subcontractor's Legal Name: _____ Page _____ of _____ pages

	Information		
Contract Identification	_____		
Award date	_____		
Completion date	_____		
Role in Contract	<input type="checkbox"/> Contractor	<input type="checkbox"/> Management Contractor	<input type="checkbox"/> Subcontractor
Total contract amount	_____		US\$_____
If partner in a JVCA or subcontractor, specify participation of total contract amount	_____ %	_____	US\$_____
Employer's Name:	_____		
Address:	_____		
Telephone/fax number:	_____		
E-mail:	_____		

Specific Experience in Key Activities (cont.)

Form EXP – 2.4.2(b) (cont.)

Bidder’s Legal Name: _____ Page _____ of _____ pages

JVCA Partner Legal Name: _____

Subcontractor’s Legal Name: _____

	Information
Description of the key activities in accordance with Sub-Factor 2.4.2(b) of Section III, Evaluation and Qualification Criteria:	
Amount	
Physical size	
Complexity	
Methods/Technology	
Physical Production Rate	

Section V. Eligible Countries

Eligibility for the Provision of Goods, Works and Related Services in Bank-financed Procurement

A. Provision at Paragraph 1.6 of the Bank's Rules and Procedures for Procurement of Goods and Works

1.6 The African Development Fund permits firms and individuals from all countries to offer goods, works and services for ADF funded projects.

PART 2 – Employer’s Requirements

Section VI. Requirements

Table of Contents

Drawings 171
Supplementary Information 177

TECHNICAL SPECIFICATION**Specifications**

Wherever reference is made in the Contract to specific standards and codes to be met by the goods and materials to be furnished, and work performed or tested, the provisions of the latest current edition or revision of the relevant standards and codes in effect shall apply, unless otherwise expressly stated in the Contract. Where such standards and codes are national, or relate to a particular country or region, other authoritative standards that ensure a substantially equal or higher quality than the standards and codes specified will be accepted subject to the Project Manager's prior review and written consent. Differences between the standards specified and the proposed alternative standards shall be fully described in writing by the Contractor and submitted to the Project Manager at least 28 days prior to the date when the Contractor desires the Project Manager's consent. In the event the Project Manager determines that such proposed deviations do not ensure substantially equal or higher quality, the Contractor shall comply with the standards specified in the documents.

TECHNICAL SPECIFICATION

GENERAL

Description of the works

The contract works include:

- Borehole drilling
- Testing pumping
- Supply and installation of solar panels and pump
- Supply and Installation of a 10,000 litre Roto tank or an equally approved plastic tank
- Fencing of borehole compound
- Construction of a water Kiosk with slab for installing water tank.

Provision of equipments material and labour

The contractor shall provide all equipments, transport consumable materials and labour necessary for the satisfactory completion of the works in compliance with the specifications herein. The Project Manager reserves the right to inspect plant and materials prior to contractor selection, and may reject plant or material that in his/her opinion is substandard or inappropriate. The contractor shall provide full descriptions of all plants to be deployed for these works. The contractor shall present method statements describing in detail the proposed approach to work.

The contractor shall provide summary detail of the experience of key personnel to be deployed for these works.

Occupation of site

The employer will provide land on which the works shall be constructed. The contractor shall be given possession of such parts of the site that he requires for activities related to construction works including storage of raw materials, equipments and setting up of camp during the period of contract provided his operation does not interfere with the daily activities of the employer.

The Contractor shall not enter upon or occupy with men, tools, equipment and materials any land other than the land or right of way provided by the employer

Diligent performance

The contractor shall at all times perform the Works diligently and in accordance with sound professional practice. He/she shall not proceed

from one stage of works to another without the express permission of the Project Manager

Decisions regarding Temporary halt, discontinuing of any element or part of any element of these works, or abandonment of these works, shall be discussed jointly between the contractor and the Project Manager before any further actions are authorized by the Engineer. The Project Manager's decision shall be final.

The Engineer will require a written submission justifying any steps taken by the successful bidder taken without the Project Manager's approval. An unsatisfactory explanation shall lead to non-payment for works undertaken without prior agreement, and may be included for consideration as liquidated Damages.

Drawings

The project drawings shall comprise

- (a) The drawings attached to tender documents
- (b) Such other drawings and/or sketches as are issued from time to time by the Project Manager to deal with design modifications in response to on-site conditions.

Record drawing

As the work proceeds the Contractor shall mark up 'As Built' details on a set of prints of the contract Drawings modified to portray the works as actually constructed and issue to the Project Manager for approval within 7 days of completion of the works covered by each drawing.

Level datum

The Project Manager will establish on site temporary benchmark and will assign a value to it. The Contractor shall establish and maintain such additional benchmarks as are necessary; the form of such benchmarks shall be approved by the Project Manager.

Contractor's staff, communication, offices etc

General

The contractor shall advise the Project Manager at which of his offices any notices may be served in accordance with the conditions of contract.

Language of correspondence and records

All communication from contractor to the Project Manager and the Project Manager shall be in English language.

All site books, time sheets, records, notes drawings, documents, specifications etc. shall be in English language

Contractor's duty staff & offices

At least one responsible senior representative of the contractor shall be immediately available at all times and he shall be on site during normal working hours.

To such representative shall be delegated full authority to confer with Project Manager and to take all steps and to issue all those instructions which may be required in an emergency to ensure the safety of all personnel of the works and of all the Employer's and other property on the site and in the immediate vicinity thereof. The Project Manager may from time to time at his discretion after taking into consideration all the prevailing conditions allow some relaxation of this clause but such relaxation shall be made only with his written permission and subject to any special conditions which he may then require.

The contractor shall provide and maintain at the site, offices for the use of representative and to which written instructions by the Project Manager can be delivered. Any instructions delivered to such offices shall be deemed to have been delivered to the contractor.

Public Relations

The contractor shall designate within his site organization competent staff whose responsibility shall be to ensure good relations.

The location of all yards, stores, workshops, offices, etc. shall be agreed beforehand with the Project Manager and shall be such as to avoid obstruction and nuisance to public and/or the client.

The contractor shall provide and maintain at or near the site suitable and sufficient shelters, mess rooms, washrooms, latrines etc. as are necessary and customary, to the satisfaction of the Project Manager Project Manager and in accordance with the law and regulations of the relevant authorities.

Accommodation for workmen

Where the contractor wishes to construct camp to accommodate his labour, the following requirements shall be adhered to and shall also be subject to the requirement made by the District or Provincial Administration or any local Authority.

Demolition of contractor's temporary structures

The Project Manager may at any time before the end of the period of maintenance give the contractor notice in writing to demolish and remove

those buildings and works which are no longer required, whereupon the title to such buildings and works and materials connected therewith shall revert to the contractor. After the demolition and removal of building and works as required by the Project Manager and contractor shall level, clear, restore and make good the sites and surrounding ground and fill in and compact all latrines, drains, pits and similar works leaving the satisfaction of the Project Manager.

First aid outfits

The contractors shall provide and maintain in an easily accessible place at the site of the works adequate first aid outfits for the whole duration of the contract, to the satisfaction of the Project Manager. The contractor shall have available at all times a suitable vehicle for conveyance of the sick or injured people to hospital.

Protective clothing

The contractor shall provide all protective or any other special clothing or equipment for his employees that may be necessary.

Inspection by Project Manager during period of defects liability

The Project Manager will give the contractor due notice of his intention to carry out any inspection during the period of Defects Liability and the contractor shall hereupon arrange for a responsible representative to be present at the times and dates named by the Project Manager. This representative shall render all necessary assistance and take note all matters and things to which his attention is directed by the Project Manager.

Advertisement

No advertisements shall be placed on any boarding or scaffolding erected for any purpose connected with the contract without the written permission of the Project Manager.

Site investigations

- (a) Ground levels shown on the drawings are believed to be correct. Should the contractor consider the levels shown to be inaccurate he must draw the attention of the Project Manager to the discrepancy before interfering with the existing ground.
- (b) The Contractor must make such site investigations as he thinks fit and satisfy him/her as to the nature of the ground and availability of materials.

Work Programme

The contractor shall submit a work programme showing the sequence and timing of the various stages in the execution of the works as per the conditions of contract.

Facilities for the Project Manager

The Contractor shall provide for the Project Manager or his representative:

- (a) Such instruments as are necessary to enable the Project Manager to check the setting out and make such inspections as he may deem necessary.
- (b) Such labour and assistance as may be required.
- (c) Any facilities necessary to enable the Engineer to take samples
- (d) Provide a temporary site office during the contract period.

Testing facilities

- (a) The Contractor shall provide laboratory facilities on site suitable for carrying out tests as shown:-
 - (ii) Concrete
 - Slump
 - Crushing strength
 - (iii) Aggregates
 - Particle Size
 - Impurities
- (b) Should the contractor so wish he may make arrangements for the necessary tests to be carried out by a Laboratory to be approved by the Project Manager.

Water supply

The contractor will arrange to provide water for use in the camps and on the works. The Contractor must provide any treatment necessary to ensure it is suitable for use as in accordance to health regulations.

Electrical supply

The Contractor must provide his own source of electricity if he so requires.

Security

The Contractor will be responsible for the security of the Works and of site installations during the Contract period. He must provide such fencing, watching & lighting as he deems necessary.

Description of the materials and workmanship

The following apply to all sections hereafter.

(a) Materials

Materials, commodities, components and equipment are to be new and unused unless otherwise specified. Handle, store, fix and protect all commodities with care to ensure that they are in perfect condition when incorporated into the work and handed over on completion.

(b) Manufacturer's recommendation

Handle, store and fix every commodity strictly in accordance with the printed or written recommendations of the manufacturer and/or supplier. Supply the Project Manager with copies of the manufacturer's recommendations. Inform the Project Manager if the manufacturer's recommendations conflict with any other specified requirements, and obtain his instructions before proceeding.

(c) Standards

Where commodities or workmanship are specified by reference to Kenya Bureau of Standards (K.S.), or British Standards (B.S.) or Codes of Practice (C.P.) or International (I.S.O.), or other standards, such standards are deemed to be the latest published at the time of tendering. The Contractor will be deemed to have read and understood the standards specified, and no claim for want of knowledge will be allowed. The substitution of commodities or standards of workmanship complying with other standards may be allowed at the discretion of the Project Manager, but application for permission for such substitution must be made in writing in sufficient time to allow adequate investigation. Obtain Certificates of Compliance with standards and supply to the Project Manager on request.

(d) Local conditions

All materials, commodities, components and equipment must be suitable for use in tropical climates.

Samples

The Contractor shall submit to the Project Manager samples of materials to be used in the works, the samples must be fairly representative of the bulk to be supplied. Samples should be subject to relevant tests before submission and Test Certificates should accompany the samples.

Clearing site on completion

The site, including borrow pits and spoil dumps shall be carefully tidied up on completion, and shaped to avoid ponding, holes, and dangerous slopes. The borrow pits and spoil dumps must be covered with topsoil neatly trimmed and the whole site left in a tidy and satisfactory condition.

EARTHWORKS

Clearing in general

Clear the area of the permanent works, and borrow pits of all vegetation and destroy by burning or otherwise.

Stripping top soil

N/A

Excavation and classification

Excavation shall be carried out to the lines and levels shown on the drawings or to such other lines and levels as the Engineer may direct.

Excavation in excess of the lines and levels shown on the drawings or without the approval of the Engineer will be rectified by the Contractor at his expense in a manner approved by the Engineer.

Any patches of unsuitable ground in the bottom of the excavations shall be excavated to such additional depth as the Engineer may direct.

Excavated material shall be taken to embankment fill or to spoil tip as the Engineer may direct.

Excavation must be kept dry and the sides supported as necessary. Excavation classification shall be as in the Ministry of Works Standard Specification (MOWSS) Section 5.

Class 1 "Rock" or "Hard Material" shall include all materials which in the opinion of the Project Manager requires blasting or the use of metal wedges or the use of compressed air drilling for its removal or cannot be extracted by ripping with a tractor of less than 180 hp. and rear mounted heavy ripper. Individual boulders greater than 0.2 m³ in volume shall be included in this class when their nature and size are such that they cannot be removed without recourse to one of these methods.

When a portion of excavation contains 75% or more by volume of boulders of this order such portion shall be considered as class 1 material throughout.

Class 2 "Normal" or "Soft Material" shall include all material, which, in the opinion of the Engineer, does not require blasting and metal wedges and sledge hammers, or compressed air drilling or rooting or ripping.

It shall include wearing course gravel stones and boulders less than 0.2 m³ in volume that can be removed without recourse to these methods.

Class 3 "Compacted Gravel" or "Decomposed Rock" shall include all material such as consolidated murrum and decomposed stratified rock, stones or boulders less than 0.2 m³ in volume which are harder than "soft" or "normal" material in that they may be extracted by ripping as defined in Class 1, or in confined spaces by hand excavation using compressor tools, provided all other reasonable steps to the satisfaction of the Project Manager have been taken to facilitate the removal by other methods.

"Waterlogged Material" material (Class 2 and Class 3) that is excavated in a waterlogged condition and necessitates de-watering and pumping operations, provided all reasonable precautions have been taken by the contractor to dewater the material to the satisfaction of the Project Manager.

Blasting

The prior approval of the Project Manager must be obtained and the methods approved if the Contractor wishes to remove rock by Blasting. The handling and use of explosives must comply with the explosives act or the department of mines and geology regulations. All necessary precautions to prevent injury or Damage to person or property must be taken. Generally blasting on the Weir site is to be avoided.

Borrow areas

N/A

Spoil tips

Surplus or unsuitable materials are to be disposed of in spoil tips to be approved by the Project Manager. Spoil tips must be neatly graded, properly drained, and have stable slopes and a tidy appearance.

Earthfill

The embankment is to be built of selected soil as specified and shown on the drawings. The earthfill shall be of cohesive material of low permeability, with negligible organic matter.

Specially selected material free from stones shall be used in the cut off and central zone; the upstream zone shall also be free of stones, the downstream zone may have small quantities of stone not exceeding 25 mm.

Compaction of earthfill

Earth fill shall be placed and mechanically compacted in layers, approximately horizontal, to give a finished thickness of not more than 150 mm after compaction to 95% of Proctor Maximum Dry Density. Each layer shall be scarified to ensure a satisfactory bond with the next overlying layer, and water shall be added if necessary to ensure uniform moisture content. Subsequent layers will be placed only after the previous layer has been ratified by the Project Manager.

Heavy rollers of a type and weight to be approved by the Project Manager shall be used for compaction. In the cut off trench and other confined spaces compaction in area which the rollers cannot serve shall be by means of approved pneumatic tampers.

BOREHOLE DRILLING AND CONSTRUCTION

BOREHOLE DRILLING**GENERAL**

Wherever reference is made in the Contract to specific standards and codes to be met by the goods and materials to be furnished, and work performed or tested, the provisions of the latest current edition or revision of the relevant standards and codes in effect shall apply, unless otherwise expressly stated in the Contract. Where such standards and codes are national, or relate to a particular country or region, other authoritative standards that ensure a substantially equal or higher quality than the standards and codes specified will be accepted subject to the Project Manager's prior review and written consent.

This contract comprises the drilling, construction, development, test pumping and water quality analysis.

REGULATIONS AND STANDARDS

The borehole shall be drilled at the site identified by the investigating hydro-geologist and confirmed by Project manager. It shall be drilled to

a depth specified in the hydrogeological survey report. It shall be drilled through all strata encountered.

The Employer will acquire the relevant permits and Government authorizations.

MOBILIZATION, DEMOBILIZATION AND RESTITUTION

(a) The Contractor shall mobilize to the site in accordance with the Agreed Programme. The sum for mobilization/demobilization shall include transportation of machinery, erection, dismantling and preparation of temporary camp as the Contractor deems necessary, provision of drilling and development fluids (bentonite, foam, and water), water for camping, personnel sanitary facilities.

(b) The Contractor shall minimize disturbance to neighbouring plots. This shall particularly include ensuring that bailed fines and pumped test water are discharged in a manner that does not create a nuisance either to the public or private property.

(c) Site re-instatement under the conditions of contract shall include the removal of all hydrocarbons spilled, leaked or otherwise released and associated packaging and cotton waste. Site re-instatement is deemed an integral part of mobilization. This activity shall be costed taking into account the items above and expressed as a lump sum.

DRILLING

(a) Unless otherwise approved by the Project Manager, drilling shall be by the air hammer method, or by flush rotary drilling method. Drilling shall continue through all strata encountered. Drilling fluids and additives used must be approved by the Project Manager prior to use. The Contractor shall provide the appropriate tools and equipment and maintain them in good condition capable of operating to the manufacturer's rating to ensure a smooth, straight hole.

(b) Drilling shall continue to the stipulated total depth at a minimum diameter of 205mm (8 inches) to provide for a finished borehole of a cased internal diameter of 152mm after allowing for 50mm thick gravel pack and temporary casings as found necessary. The Project Manager reserves the right to stop drilling operation if he considers that further drilling is unlikely to be advantageous. In this event payment shall only be made for the amount of work actually executed.

(c) All materials used in the borehole construction other than temporary works shall comply with the relevant standard specifications. A tolerance in dimensions will be permitted provided that the material quality is not inferior to specification and work is in no way impaired.

- (e) The boreholes shall be drilled straight and vertical.

SAMPLE COLLECTION, STORAGE AND RECORD KEEPING

(a) Samples of the drill cuttings returned to the surface shall be collected at two (2) metres intervals, dried and bagged. Each bag shall be clearly marked with the sample depth interval and borehole number. The Contractor shall record the depth and any zone of lost circulation for which no sample was taken.

(b) The Contractor shall maintain a log of the penetration rate on a metre by metre basis, in minutes per meter drilled. A stopwatch shall be used for this purpose so that only the net drilling time is recorded, excluding any time taken in drilling disruptions.

(c)The depth of any voids, or of particular rapid penetration, or significant changes in rig noise shall also be noted.

(d) Water level shall be measured and recorded at the start and end of every shift, after significant breaks in activity (such as meal breaks), and during periods of plant downtime (as appropriate). The water levels shall be measured using a sounding and/or lighting dipper approved for use by the Project Manager.

SUPPLY AND INSTALLATION OF CASINGS AND SCREENS

CASING AND SCREEN SPECIFICATIONS

a). Casings shall be new, 152mm (6 inches) internal diameter, black pipe class B, with a minimum wall thickness of 4.0mm in 6 meter lengths.

b). Mill slotted screens shall be constructed from new 152mm internal diameter black pipe class B with a minimum wall thickness of 4.0mm. Slots shall not exceed 1.0 mm in width, and should constitute not less than 6.0% open space area. Gas slotted casing screens are not acceptable.

CASINGS AND SCREEN INSTALLATION

(a). Before installation of the casings and screens, the Contractor shall ensure that the hole is clear to the total depth and shall flush out any backfilled materials present. The Project Manager shall provide the design of the casings and screens string prior to installation by the Contractor.

b). Casing jointing shall be by either flush square-section threading or tree pass electric arc welding. Screens may be welded to casing, or

screw-jointed by means of flush square-section threads. Externally socket joints may be welded to the casing, or screw-jointed by means of flush square-section threads. Externally socketed joints will not be accepted. Where screwed joints are deemed by the Project Manager to be below standard, joint shoulders shall be spot welded at 900mm interval around the casing circumference at no extra cost. If screens and casing are to be welded, the appropriate welding electrode must be used.

c). During welding, casing and screen lengths must be held absolutely vertical in order to ensure a plumb installation. All joints to be welded must be levelled at the butt end; three continuous weld passes must be made to ensure a sound joint and the oxide coating be removed before the second and third passes.

d). Burn-through and subsequent deposition of metal on the inside of the casings and screens must be avoided. The base of the casing shall be sealed, unless otherwise directed by the Project Manager, with a circular plate of black pipe class B of thickness not less than 4.0mm (1/4 inch) fixed with a continuous weld to the casing strip. The appropriate welding electrode shall be used. The weld passes will be made, with oxide coating removed prior to the second and third passes. The top of the casing straight shall terminate not less than 600mm above the highest recorded level of ground at the site.

e). The contractor shall be responsible for the provision of temporary casings as necessary, including the insertion and removal. Where the Project Manager deems it necessary to have temporary casings left in the borehole as a measure of securing the borehole, this will be indicated in the item for other works in the bill of quantity.

ADMISSIBLE RATES

a.) Rates shall be expressed as supply and installation of casing or screen per Unit Linear Metre.

SUPPLY AND INSTALLATION OF GRAVEL PACK

SPECIFICATIONS

a). The Contractor shall supply and install filter pack/formation stabilizer. The material shall be 2-4 mm diameter, clean well rounded riverbed siliceous gravel with no more than 5.0% non-siliceous material. The pack must be approved by the Project Manager prior to installation. Granular calcium hypochlorite will be introduced into the annular space along the pack material at a concentration of 500 grammes per cubic metre of pack.

The gravel pack shall be placed in the production boreholes to a thickness of 50mm around the casing up to where all screen zones are covered with the gravel as per the Project Manager's satisfaction.

This will initiate the process of sterilizing the wellbore. The Contractor shall provide the Project Manager with the bulk density of the pack material (Kg/M³).

b). Installation of the filter pack/formation stabiliser may be water wash down or reverse circulation methods. In the latter case a pump set or airlift string shall be installed in the bore so as to encourage material settlement. The filter pack shall terminate not less than 3.0 metres above the uppermost screen when stabilized, or as otherwise directed by the Project Manager. The Contractor shall provide a means by which this level shall be measured.

ADMISSIBLE RATES

Rates shall be expressed as supply and installation of gravel pack per Unit Cubic Metre.

INSTALLATION OF BACKFILL

SPECIFICATIONS

a). Backfill material shall comprise of fine clayey drill cuttings and shall be installed from the top of the filter pack to 3.0 metres below ground level unless otherwise directed by the Project Manager. The installation method must ensure that no bridging occurs within the annular space.

b). The Contractor shall measure the depth to the top of the backfill and provide the means by which this level may be measured.

ADMISSIBLE RATES

Rates shall be expressed as installation of backfill per Unit Linear Metre.

DEVELOPMENT

Development shall comprise both Physical and Chemical development, and shall include the following operations:-

BOREHOLE CLEANING

a). The Contractor shall clean the borehole to its "completed depth" using any of the methods listed below or as otherwise authorized by the Project Manager:-

- By bailer with percussion drilling rig
- By means of airlift, which may use a light or stable foam to assist in the removal of materials from the borehole.
- By means of educator airlift, with or without light or stable foam.

b).Bailers and other down whole plant shall adopt diameter limits of half a normal size or smaller (12.5mm or ½ inch) than the smallest casing or screen diameter.

c).Water levels shall be measured and recorded at the start and end of every shift, at significant breaks in activity (such as meal breaks), and during periods of plant downtime (as appropriate). Water levels be measured using a sounding and/or lighting dipper previously approved by the Project Manager.

d).The borehole shall be deemed clean when measured drilled depth has been reached and when insignificant or no materials is removed from the base of the borehole. Cleaning costs shall be expressed as a rate Per Hour.

CHEMICAL DEVELOPMENT

a).When the Project Manager has deemed the borehole clean; he may instruct the Contractor to commence with Chemical development. Chemical development shall comprise of an approved Polyphosphate as a disaggregate that shall break down the silty concentrations, any build up clay or silts, or other fine materials within and adjacent to the borehole. The decision as whether chemical development shall be adopted and what dosage rates shall be made by the Project Manager.

b). Typical dosage shall comprise of powdered Sodium Hexameta phosphate dissolve in hot water. The polyphosphate shall be dosed at 10 to 15 Kg/m³ of water depending on the concentration of clays in the aquifer matrix. This shall be mixed with calcium hypochlorite at a dose of 200grammes per cubic metre to inhibit bacteria activity. The volume of polyphosphate dosed water shall be one and a half times the Volume of water within the screen section.

c) Both polyphosphate and added water shall be introduced by means of a pipe, the bottom end of that shall be located in the middle of the screen section of the borehole. The Contractor may get the liquids into the screened section using a jetting head if he wishes.

d). After dosing, the borehole shall be left overnight to allow disaggregation to occur. The borehole shall then be subject to physical development.

e).Chemical development costs shall be expressed as an Hour rate, and include all labour and materials (including clean water) required

for the operation. Chemical development undertaken by a Contractor familiar with the technique shall take no longer than three (3) hours.

PHYSICAL DEVELOPMENT

(a).Physical development may adopt any of the commonly used methods, including but not necessarily restricted to the following:-

- Surging
- Bailing
- High Velocity Water Jetting
- Airlift raw hiding
- Airlift raw hiding with educator pipe.

b). Development shall be considered complete when the water discharged is clear and contains no more than an estimated 5 parts per million of suspended solids and the borehole has been restored to the cleaned total depth or as otherwise directed by the Project Manager.

c) The Contractor shall describe the method he proposes to adopt and the plant required for physical development in his method statement. **Over pumping** shall not be considered a development method. The rate submitted by the Contractor for physical development is deemed to include installation and removal of necessary plant. The quantities given in the bills of quantities only apply to actual development time. Costs for physical development shall be expressed as an Hour Rate.

AQUIFER TESTING

Borehole testing will be conducted according to British Standard BS 6316 (1992) (Code of Practise for Test Pumping of Water Wells). The following elements are required.

- A pre-test
- A step drawdown test
- A constant discharge test
- A recovery test

INSTALLATION, PLANT AND METHODOLOGY

Pumping plant and dipping tube shall be installed in the borehole to be tested. The Contractor shall investigate and agree with the Project Manager the anticipated discharge and pump intake depth.

PUMPING PLANT

- i) Pumps used for test pumping may be electrical submersible or surface-mounted turbine pumps or reciprocating pumps.
- ii) Any pump used in tests must have a fully functioning **non-return valve** either in the pump itself or in the rising main immediately above the top of the pump.
- iii) The Contractor must have pumps covering the anticipated discharge range.
- iv) The water pumped from the borehole shall be discharged to waste at a distance and in such a manner that it does not pond or flow back towards the borehole.
- v) The Contractor must provide a generator or other prime mover for powering the pump, as power is not necessarily available at the sites.

DISCHARGE MEASUREMENT AND CONTROL

Discharge measurements shall be by an approved accurate method, such as an Orifice Plate, calibrated flow meter or a V-notch weir. If volumetric methods are proposed, the Contractor will ensure the container to be used has been calibrated. When time to fill measurements is made, each discharge measurement shall be calculated from the average of three time measurements. Discharge shall vary by no more than 15% across each step of step drawdown test, and across the constant discharge test.

WATER LEVEL MEASUREMENT

Water level measurements shall be by electric sounding and/or lighting dipper, and shall be made in a dipper tube installed alongside the test pump rising main and tied securely to it. The Project Manager will check the dipper for stretch and any other inaccuracies prior to accepting its use. Accuracy measurements must not be less than 1.0 cm. Water level measurements using an airline will not be acceptable on the grounds of poor precision.

TIME MEASUREMENT

All times shall be measured by means of a stopwatch. The Contractor shall ensure that spare batteries etc for all equipment are available prior to commencing tests.

PRE-TEST

The pre-test will check all equipment, determine the range of discharge for the step drawdown test and set the globe values for the first step discharge rate. Pre-test shall not exceed three (3).

STEP DRAWDOWN TEST

- The step drawdown test will comprise five (5) steps tests of sixty (60) minutes each, with no recovery phase between successive steps. The step drawdown test shall not start until water level has returned to the true static water level, unless otherwise directed by the Project Manager.
- Typically, individual step discharges would comprise 25%, 50%, 75%, 100% and 125% of the anticipated production discharge rate.
- Discharge increments shall be effected as nearly instantaneously as possible and once set shall not be changed except by instruction of the Project Manager.
- Discharge variations and measurement shall be effected by means of the globe valve and manometer gauge as follows;

A globe valve of suitable diameter shall control the discharge and on the upstream side of this, not closer than six (6) pipe diameters from the valve, a manometer tapping and gauge will be installed such that it can be clearly seen by any person using the valve. This will be used during the step drawdown tests for the flow control purposes.

CONSTANT DISCHARGE TEST

Constant discharge test shall typically last not less than twenty four (24) hours, or as otherwise determined by the Project Manager. A water sample will be procured towards the end of the test for subsequent analysis by a competent laboratory.

RECOVERY TEST AND REMOVAL OF PLANT

Recovery tests shall not continue for more than twenty four (24) hours, or as otherwise directed by the Project Manager. Only after the completion of recovery data collection may pumping and ancillary plant be removed from the borehole, though above ground components may be dismantled during the recovering phase.

ADMISSIBLE RATES

Rates of pumping and recovery are deemed to include the cost of plant installation and removal. The rates are deemed inclusive of installation, removal, plant use, testing and data collection.

WATER SAMPLING AND ANALYSIS

- In the closing hour of the constant discharge test a water sample shall be collected for chemical and bacteriological analysis by a competent laboratory. The water samples shall be collected in containers supplied by the laboratory, in the manner conventionally used by the laboratory.
- The Contractor's unit rate of sampling and analysis will include the cost of analysis and transportation to and from the laboratory for the sampling exercise.

BOREHOLE DISINFECTION

After removal of test equipment, the borehole shall be disinfected with Chlorine/water solution at a concentration of 50 milligrams per litre or greater of free chlorine. This will be sprayed into the borehole so as to ensure that all exposed borehole wall surfaces are coated. In preparing their Tenders, Contractors should allow for one (1) cubic metre of solution per borehole. This item shall be costed as a unit Lump Sum

BOREHOLE HEAD WORKS

SANITARY SEAL CASING

A sanitary seal shall be constructed at the wellhead. This shall comprise the following elements:

- A 3.2 metre length of internal diameter 205 mm (8 inch) plain black pipe class B sanitary steel casing installed around the permanent casing string.
- A grout seal between the 254mm sanitary seal casing and the 152 mm Permanent casing string.
- A 1.0x1.0x1.0 metre reinforced concrete block (Y8/1:2:4) cast around the Sanitary seal casings.
- A lockable steel cap.

GROUT SEAL

A sanitary ground seal shall be installed between the 152 mm (6 inch) and 205 mm (8 inch) casings and grouted into place. Grout shall be a cement slurry, or cement and fine sand and shall have a density of at least 1175 Kg/lit. This shall be introduced into the annular space from the top of the inert backfill to the ground level, using a method that must be approved by the Project Manager.

CONCRETE PLINTH

The ground surface at the wellhead shall be excavated to a depth of one (1) metre, and be one metre square, to allow s Concrete Plinth to be cast. The 1.0x1.0x1.0 metre pit will be filled with concrete, to be finished flush with the ground surface. Concrete shall be 1:2:4 OPC: sand: half-inch ballast. This must be cast with two 0.8 metre lengths of 12 mm reinforcing steel bar welded to the 205 mm (8 inch) casing, 0.7 metre below ground level.

TEMPORARY CAP

The top of the borehole shall be sealed with a cap that shall comprise a round plate of mild steel, of thickness not less than 3.0mm. This will be continuously welded in single pass to the mild steel borehole casing or should be lockable.

RECORDS

After completion of all works at the borehole, the Contractor shall submit to the Project Manager within four (4) days a complete document with the following additions:-

- Drilling penetration Log
- Geological Log
- WRMA 009A Borehole Completion Record (Three Complete Sets of Completion Reports shall be submitted.

TECHNICAL LITERATURE

A Tenderer **must** submit the following information together with the Tender documents to assist in fair evaluation:-

- Technical specifications on drilling rig and other ancillary equipment (make, model, rated capacity etc)
- Particulars and specifications of materials used in the construction of the borehole.
- Any other information the tenderer may deem is important in evaluation as well as BOOSTING his/her chances of winning the tender.

ELECTRO – MECHANICAL WORKS SPECIFICATIONS

ELECTRICAL WORKS

REGULATIONS AND STANDARDS

The complete solar installation shall be carried out by a competent Contractor and in accordance with the specifications and compliance with the following;

- (a). Kenya Bureau of Standards
- (b). Regulations for the Solar/Electrical Equipment of Buildings (Latest Edition) issued by the Institution of Electrical Engineers of Great Britain.
- (c). IEC standards.
- (d). Electric Power Act and the Rules made there under.
- (e). Kenya Power & Lighting Co. Ltd Regulations and Bye-Laws.
- (f). Government Electric Specifications GES 1 and 2 which can be viewed at the office of the Chief Electrical Engineer, Ministry of Roads, Public Works and Housing.
- (g). Industrial Safety Regulations currently in force.

SWITCH GEAR PANELS, DISTRIBUTION BOARDS ENCLOSURES, INSTRUMENTATION PANELS, STARTER PANELS, BUS-BAR CHAMBERS, CONSUMER UNITS, JUNCTION BOXES AND OTHER ELECTRICAL ENCLOSURES

Unless otherwise specified, all shall be surface mounting, water tight, corrosion resistant, vermin-proof, termite-proof, dust-proof and resistant to attack by oils and grease. They shall be fabricated from heavy gauge 14swg, folded, spangled, galvanized and rust protected sheet steel of minimum thickness 1.5mm. They shall be finished in a two tone, heat resistant, non-peeling-off stoved gray enamel paint or epoxy powder coating.

ELECTRIC CABLES

Unless otherwise specified, all cables shall be made of copper material and conform to BSS 5004, 500/600 volts grade.

(i). UNARMoured CABLES

They shall be PVC insulated.

(ii). ARMoured CABLES

They shall be PVC SWA PVC copper cables.

(iii). BOREHOLE CABLES

They shall be made from tough flexible rubber material that will not allow water to seep through when submerged in the borehole water.

GS CABLE TRUNKING

The trunking shall be manufactured from heavy duty hot dip galvanized mild steel sheet of minimum thickness 1.15 mm with screw-in and twist-to lock top lid.

PUMP SET STARTER

It shall be 3-Phase, 415 V ac, 50/60 Hz Direct-On line. It shall be in a water tight, front access, hinged door, lockable enclosure, comprising of the following components among others fully wired and labelled.

The starter shall be **Telemecanique, ASEA, MEM, Crabtree, Siemens, Klockner-Moeller or Sprecher-Schuh**. It shall be fully wired and 3 No. sets of schematic and control wiring drawings MUST be supplied along with the starter.

- Appropriate rating contactors.
- Appropriate rating thermal overload.
- Start, Stop/Reset push buttons (green marked "START", black marked "STOP/RESET").
- Integral TPN (MCB) type 2.
- 1 No. 50x50mm AC ammeter of appropriate range.
- 1 No. 50x50mm AC voltmeter of range 0-500 vac.c/w protection MCB/fuse

- Over/Under voltage and phase failure protection relay set at 380 and 440 vac.
- 2 No. Water level control relays.
- Pilot indicator lights (green marked "PUMP RUN", red marked "OVER LOAD TRIPPED", yellow marked 'BOREHOLE LOW', white marked "TANK HIGH" etc.
- Hours run counter range 0-99999 hours.
- Cable terminal blocks of appropriate rating.

BOREHOLE MOTOR

The motor shall be the two pole canned asynchronous, 3 phase, 415vac, squirrel cage, induction type, continuously rated and of minimum CLASS "B" insulation.

The entire body including the shaft shall be made of heavy duty stainless steel material.

The motor shall be supplied complete with 3 lead copper tail cable.

BOREHOLE PUMPS

The pumps shall be the high pressure, vertical mounting, multi-stage, centrifugal type running at a full load speed of not less than 2800 rpm.

The entire pump body including the strainer, cable guard, non-return valve, impellers, shaft, locking nuts and washers shall be made of heavy duty stainless steel material.

The bearings shall be the water lubricated type, wear resistant.

The impeller(s) shall be hydraulically and dynamically balanced.

WATER LEVEL CONTROL ELECTRODES

All the electrodes shall be made of stainless steel material **AISI 304 as Omron F03-01, Londex, Ascor** similar approved quality made of stainless steel.

BOREHOLE ELECTRODES

They shall be of size 6.0 mm diameter and 120mm length (D6x120mm) and in their tough moulded shrouds.

WATER TANK ELECTRODES

They shall be of size 6.0mm diameter and varying length dependent on the depth of the tank or intended control water levels. They shall be in a circular, water tight, electrically insulated (500 vac) tough moulded enclosures with screw top and knock-outs for 20mm diameter conduit and rubber grommets. The electrodes shall have tough plastic ring separators of size D75x3mm thick fixed at 300mm intervals for the entire length.

BOREHOLE COMBINED PIPE AND CASING CLAMP

The clamp shall be the heavy duty type. It shall comprise of 3 pieces; the bottom half clamps to the borehole casing, while the top portion which rests on the top of the casing clamps to the pipe column and holds it centrally in the casing bore.

The clamp covers the bore and so prevents foreign matter falling into the borehole. The clamps shall be made of steel material of minimum thickness 6mm.

BOREHOLE SUNDRIES

Unless otherwise specified, the words "BOREHOLE SUNDRIES" shall mean the following items to be used in the installation, support and inter-connection of the borehole pump and drop pipes to the rising mains. Unless otherwise specified, the GI fittings shall be of the same diameter as the drop pipes.

-6 rolls of 6metre water proof adhesive rubber tape.

- 1 No. Tee, 4 No. sockets, 4 No. nipples, 2 No. 90° bends, 1 No. plug.
- 2 No packet of 250mm plastic cable ties
- 4 Litres of Boss black type COLAS RC.

RC CABLE AND PIPE ROUTE MARKERS

They shall be of size 1100mmLx200mmWx80mmT with the words “POWER CABLE”OR “WATER PIPE” in 40mm height letters mould cast in black indelible colour in the concrete. They shall be cast using Y8 RC concrete of mix ratio (mix ratio 1:3:6).

HATARI TILES

The tiles shall be used to cover the underground armoured cables for protection against mechanical damage. They shall be of size 300mmLx150mmWx30mmT with the word “HATARI” in 40mm height letters mould cast in the concrete. They shall be pre-cast using concrete of mix ratio (mix ratio 1:3:6).

LIGHTING FITTINGS AND SOCKET OUTLETS

LIGHTING FITTINGS

Unless otherwise specified, they shall be rated so as to operate on single phase, 220-240vac, 50/60 Hz power supply mains.

INDOOR LIGHTING FOR OFFICES

Unless otherwise specified, they shall be the energy saving type, 1200mm single fluorescent fitting as Thorn, Crab-Tree or Philips, power factor compensated and complete with choke, tube and starter.

NOTE

Pump house lighting shall be water tight and corrosion resistant to water.

EXTERNAL WALL FITTED LIGHTING FITTINGS

Unless otherwise specified, the fittings shall be the tungsten bulkhead type, Thorn, Crab-Tree or Philips IP65, dust-tight and jet-proof and rated 100 watts. The body shall be made of pressure die cast aluminium material and stoved with light gray enamel paint.

The diffuser shall be patterned mould glass bowl with captive vandal-proof nylon retaining screws, gasket seal to glass and heat resistant cable sleeves.

GS BOREHOLE PROTECTION COVER

The cover shall be all weather-proof, rectangular in shape with pitched top (3°). The cover shall be fabricated from hot dip galvanized heavy gauge (16swg) sheet steel plate of minimum thickness 1.75mm. It shall have GS solid handles and

pad locking facilities on the opposite sides. The cover shall be in an L-SHAPED steel frame (25x25x2.5mm thick).

WIRING METHODS OF ELECTRICAL INSTALLATIONS AT MEDIUM AND LOW VOLTAGE

SYSTEM “A”

Plastic insulated cables enclosed in screwed steel conduit or trunking on the surface of walls and ceilings or in the roof space.

SYSTEM “B”

Plastic insulated wires armoured cables laid on the surface of walls, cable trays, in cable trenches or ducts.

SYSTEM “C”

Plastic insulated cables clipped to the roof members and run in metal or plastic conduit drops concealed in walls or ducts formed in the fabric of the building.

PERFORATED CABLE TRAYS

The tray shall be U-shaped, fabricated from hot dip galvanized heavy gauge (16swg) sheet steel plate of minimum thickness 1.5mm.

The tray shall have 2 no. GS brackets firmly welded at the back for wall mounting. The perforations shall be 25mmLx2.5mmW spaced at 15mm interval.

CHEQUERED PLATES

The plate shall be fabricated from hot galvanized heavy gauge (12swg) sheet steel plate of minimum thickness 3.0mm with serrated top side.

SYSTEM BONDING

All non-conducting metallic parts which form part of the electrical system or are within the vicinity/route of the electrical system shall be effectively bonded to the main earthing system.

EARTHING SYSTEM

All the electrical installation earthing conductors shall be connected to the earth electrode through an earth lead. The earth lead shall be firmly connected to the electrode by means of the clamp, after which a thin film of grease or Vaseline shall be applied at the clamp area for protection against corrosion.

SOLAR PANNELS (Photo Voltaic Solar Modules)

The contractor shall supply and install solar panels and all the necessary accessories as manufactured by Solar World or Yingli Solar and should comply with the following standards:

- High efficiency multi crystalline solar cells with minimum 15% energy conversion rates to provide maximum power even under weak lights.
- High transmission rate tempered glass with an anti-reflection coating to increase the power output and provide mechanical strength
- Multi-function water proof junction box for easy connection.
- 25 year power output warranty.

ELECTRICAL / SOLAR INSTALLATION TEST RESULTS

The Contractor shall at the end of the electrical installation work carry out electrical tests on the system and ensure that the results are compliant with the I.E.E. Regulations and Kenya Power & Lighting Co. Ltd Regulations and Bye Laws currently in force before the system performance tests are carried out.

Electrical parameters to be tested are;

- Insulation between phases Mega ohms
- Insulation between phases and Earth Mega ohms
- Earth continuity test Ohms
- Earth Electrode test Ohms
- Earth loop impedance test Ohms
- Earth lead test Ohms

AVAILABILITY OF SPARE PARTS

The Contractor shall indicate local registered companies which stock spares and carry out repairs/ maintenance of the equipments installed (solar panels, motor, pump starter etc).

TECHNICAL LITERATURE

- a) The bidder **MUST** submit adequate technical literature to assist in evaluation. The literature information shall INCLUDE;
- Performance curves for the pump set (CAPACITY VS HEAD, EFFICIENCY, and POWER CONSUMPTION etc).
 - Make, type model and country of origin of the pump, motor, pump starter etc.
 - Specifications of materials used in the construction of the components of the pump, motor etc.

-
- Any other information the bidder may deem is important in evaluation as well as BOOSTING his/her chances of winning the bid.

b) The winner of the bid must submit the following;

- 1 No. set of the User Manual for the pump set.
- Written Warranty document of minimum 12 months for the pump set, starter etc.
- 1No.SET of original film and 3 No. SETS each of as-fitted electrical schematic drawings, control wiring drawings for main switch gear, pump starter, cabling and water pipe lay out between borehole and tank.

TANKS, SUPPORT STRUCTURES AND ANCILLARIES

REGULATIONS AND STANDARDS

The complete work shall be carried out as per the specifications and complying with the following regulations and standards:

- a) World health Organization Safety Regulations and Standards
- b) Kenya Bureau of Standards

TECHNICAL SPECIFICATIONS

TANK

- a) The tank shall be cylindrical in construction, vertical mounting with a strong base. It shall be non-toxic and non-absorbent. It shall be made from high density polyethylene plastic material, extruded with minimum 2% carbon black for long lasting. The process of manufacture shall be 100% free stress and provide a final seamless product that does not leak, does not impart any taste or residue.
- b) The tank shall be double layered and ribbed (inside white and outside black). The tank shall be resistant to chemicals, sunrays. The tank shall be supplied complete with water tight GI pipe connection fittings fitted in position and lockable top lid.

TANK SUPPORT TOWER ASSEMBLY

The tank support tower shall be able to support the weight of the tank full of water, with a safety factor of 1.5.

a) TOWER COLUMNS

The tower columns shall be four (4) in number. The columns shall be constructed from 100x100x 4mm SHS as per the drawings.

b) TANK SUPPORT PLATFORM

The platform shall be made of 150x100x3mm RHS with a chequered plate on top of the steel members.

c) PERIPHERY WALK WAY, GUARD RAILS

The periphery walk way shall be made from chequered steel plates of thickness 4.0 mm while the guard rails shall be L-shaped steel section of dimensions 32x32x2.5mm thickness, with two welded reinforcement runs of solid steel of diameter 8.0 mm at the middle and top.

d) ACCESS LADDERS

The access ladders shall be fabricated from solid steel sections of size 38 mm wx4.0mm thicknesses. The steps shall be made from solid steel material of diameter 10mm and spaced at 220mm interval. The ladders shall have semi-circular protection gauges constructed from steel plate strips of dimensions 25mm wx2.5mm thickness welded at 300mm interval up to 900mm above the platform. The gauge will be reinforced using vertical steel plate strips of size 20mm wx2.5mm thicknesses.

e) WATER LEVEL INDICATOR

The tanks shall be supplied complete with water level indicator assembly comprising of the float ball, wire rope, pulley, position brackets, weight all made of stainless steel material. The indicator scale shall be made from vitreous enamel material and mounted on GS plate. The scale shall be calibrated in 100mm height black lettering both in litres and cubic metres.

CONCRETE WORKS

General

(a) Code of practice

All workmanship, materials, tests and performances in connection with the reinforced concrete work are to be in conformity with the latest edition of British Standard Code of Practice (B.S. 8110 for "Structural Use of Concrete") where not inconsistent with these specifications.

(b) Contractor's plant

Not less than 30 days prior to the installation of the Contractor's plant and equipment for processing, handling, transporting, storing and proportioning ingredients, and for mixing, transporting and placing concrete, the Contractor shall submit drawings for approval by the Project Manager, showing proposed general plant arrangements, together with a general description of the equipment he proposes to use.

After completion of installation, the operation of the plant and equipment shall be subject to the approval of the Project Manager.

Materials

Cement

Cement, unless otherwise specified, shall be Portland cement of the Blue Triangle brand, or Bamburi Portland Cement brand, Mombasa cement brand or any other brand which comply with the requirements of B.S. 12 and is approved by the Project Manager. The cement shall not contain reactive volcanic ash (of not more than 10% of total weight) and the quantity of insoluble residue permitted in B.S. 12 may be exceeded. A manufacturer's Certificate of Test in accordance with B.S. shall be supplied for each consignment delivered to site.

Should the Contractor require using cement of the rapid hardening variety, he shall obtain the approval of the Project Manager and also obtain any instructions regarding the modifications to the preambles caused thereby. Any additional cost that may be caused by the use of the rapid hardening cement shall be at the Contractor's expense.

Cement may be delivered to site either in bags or in bulk. If delivered in bags, each bag shall be properly sealed and marked with the manufacturer's name and on the site is to be stored in a weather-proof shed of adequate dimensions with a raised floor. Each consignment shall be kept separate and marked so that it may be used in the sequence in which it was received. Any bag found to contain cement

which has set or partly set shall be completely discarded and not used in the Works. Bags shall not be stored more than 1500 mm in height.

If delivered in bulk the cement shall be stored in a weather-proof silo either provided by the cement supplier or by the Contractor, but in either case the silo shall be to the approval of the Engineer.

Aggregates

The aggregates shall conform to the requirements of B.S. 882 and the sources and all types of all aggregates are to be approved in all respects by the Project Manager before work commences.

The grading of aggregates shall be one within the limits set out in B.S. 882 and as later specified and the grading, once approved, shall be adhered to through out the Works and not varied without the approval of the Project Manager. Fine aggregate shall be clean, coarse, siliceous sand of good, sharp, hard quality and shall be free from lumps of stone, earth, loam, dust, salt, organic matter and any other deleterious substances. It shall be graded within the limits set out in zone 1 or 2 of B.S. 882.

Coarse aggregate shall be good, hard, clean approved black trap or similar stone, free from dust, decomposed stone, clay, earthy matter, foreign substances or friable thin elongated or laminated pieces. It shall be graded within the limits of Table 1 of B.S. 882 for its respective nominal size.

If in the opinion of the Project Manager the aggregate meets the above requirements, but is dirty or adulterated in any manner it shall be screened and/or washed with clean water if he so directs at the Contractor's expense.

Aggregates shall be delivered to the site in their prescribed sizes or grading and shall be stockpiled on paved areas or boarded platforms in separate units to avoid intermixing.

Fine aggregate

Fine aggregate shall be sand free from impurities and complying with British Standard No. 882. Grading zone 2 of Table 2.

Coarse aggregate

Coarse aggregate shall be hard crushed rock free from impurities and complying with British Standard No. 882 "graded aggregate" 20 mm to 5 mm nominal size as Table 1.

Water

Water for concrete shall be free from impurities, complying with BS 3148

Hardcore

Hardcore for filling under floors shall be good, hard stone ballast or quarry waste, to the approval of the the Project Manager, broken to pass through not greater than a 150 mm ring or to be 75% of the finished thickness of the layers being compacted, whichever is the lesser. Hardcore shall be free from all weeds, roots, vegetable soil, clay, black cotton soil or other unstable materials.

It shall be graded with smaller stones and fine materials to give a dense compact mass after consolidation. Sufficient fine material shall be added to each layer to give gradation of material as necessary to obtain a solid compact mass after rolling. Hardcore filling is to be laid in layers each of a consolidated thickness not exceeding 250 mm. Each layer shall be compacted by at least 8 passes of a 10-tonne smooth-wheeled roller or a 2-tonne vibrating roller until all movement ceases. Sufficient water is to be added to obtain maximum compaction to the the Project Manager's approval. To each layer a 25 mm thick layer of sand complying with the specification of fine aggregate for concrete shall be spread over the surface and forced into the hardcore by the use of a vibrating roller weighing not less than 2 tones. This operation should be carried out when the materials are dry and repeated whilst the sand is well watered. Should all the sand be absorbed the the Project Manager may require a further layer to be applied and the process repeated.

The top surface of the hardcore shall be leveled or graded to fall as required, and shall then be blinded with a layer of similar material broken to 25 mm gauge and finished with a 10-tonne smooth-wheeled roller. The surface so obtained shall be to the Engineer's approval.

Compacted hardcore

The sub-grade shall be compacted by a smooth-wheeled roller of 8 to 10 tonnes weight or the vibrating roller of minimum 1300 Kg., or other approved plant. The number of coverage shall be at least 10 and there shall be a 50% overlap of successive coverage. If so instructed by the Engineer, water shall be added during compaction to obtain optimum water content. Filling shall be compacted as above but in maximum 200 mm deep layers.

Sand

The sand shall be as described for fine aggregate but that for plastering shall be light in colour and well graded to a suitable fineness in accordance with the nature of work in order to obtain the finish directed.

Finishes

General

The Contractor will be required from an early stage in the contract to prepare samples, for the approval of the the Project Manager, of the various concrete finishes specified hereafter. Samples are to be prepared using the same materials and the same methods of construction, compaction, curing, etc. as the Contractor proposes to use for executing the full quantity of the work. A record of the mix, water content, method of compaction, any additives used, etc., is to be kept for each sample prepared. When the Project Manager has approved a sample it will be kept on site in an approved location. The finishes in construction will be expected to be up to a standard equal to the approved sample. Consistency in cement colour, and the colour, grading and quality of aggregates must be maintained in all finished concrete work.

Mortars

Cement mortar shall consist of one part of Portland cement to three parts sand by volume. The cement/lime mortar shall consist of one part of Portland cement, one part of lime and six parts of sand by volume.

The ingredients of mortar shall be measured in proper gauge boxes on a boarded platform, the ingredients being thoroughly mixed dry, and again whilst adding water. In the case of cement/lime mortar, sand and lime shall be mixed first and then the cement added.

All mortar is to be thoroughly mixed to a uniform consistency with only sufficient water to obtain a plastic condition suitable for toweling. No mortar that has commenced to set is to be used or re-mixed for use.

Tamped finish

Areas so specified shall be finished at the time of casting with a tamped finish to the Engineer's approval produced by an edge board. Board marks are to be made to a true pattern and will generally be at right angles to the traffic flow. Haphazard or diagonal tamping will not be accepted.

Fair face

Fair face surfaces shall be clean, smooth, even, true to form, line and level, and free from all board marks, joint marks, honeycombing, pitting, and other blemishes. Forms are to be provided with a smooth lining of plywood, steel, or other approved material which will achieve the

required finish without any general rubbing down. Rubbing down will only be permitted to remove any projecting fins at corners or joints.

Fine face

Fine face surfaces shall be for Fair face above, but to a higher standard obtained from forms provided with an impervious sheet lining of metal or plastics faced plywood in large panels arranged in an approved pattern. Rubbing down shall only be permitted after an inspection by the Project Manager. The finished surfaces shall be capable of receiving a painted finish.

Chisel-dressed finish

Chisel-dressed finish is to be carried out on any grade of concrete but not until it is at least 30 days old. The surfaces are to be fully chisel-dressed to remove a maximum of 12 mm (average 9 mm) of the surface by shearing and exposing the aggregate without excessive cracking of the surrounding matrix. Arises of columns, beams, etc., are pre-formed fair face with timber fillets set in the formwork and care must be taken in working up to these to preserve a clean line.

For vertical surfaces of walls and columns particular care must be taken to remove all sharp projections. For beam soffits this requirement is not necessary. All surfaces requiring this treatment are to have margins chisel-dressed by hand for a minimum width of 75 mm commencing from the fillet edge. Thereafter, mechanical chisel-dressing may be used, but the Contractor must ensure that a uniform texture and even plane surface is achieved. The use of sharply pointed steel tools for both hand and mechanical chisel-dressing is essential. Upon completion the surfaces are to be thoroughly wire brushed and washed down.

Protection of finishes

Wherever possible, in-situ exposed concrete finishes should be commenced at the highest level and worked progressively down the building. Precaution shall be taken to avoid staining or discoloration of previously finished concrete faces by leakage of grout from newly placed concrete. The Contractor shall, during all stages of construction, adequately protect all concrete finishes from Damage by leaking grout, knocking, paint stains, falling plaster, etc. In cases of balustrade walls to staircases and members where Damage is otherwise likely, concrete finishes shall be protected by cladding with timber, Celotex, or other approved sheeting. All Sub-contractors shall be informed accordingly on the precautions to be taken.

Blinding

All blinding concrete to be 1:3:6, or as otherwise instructed by the Project Manager in writing.

Formwork

The method and system of formwork which the Contractor proposes to use shall be approved of by the Project Manager before construction commences. Formwork shall be substantially and rigidly constructed of timber or steel or pre-cast concrete or other approved material.

All timber for formwork shall be good, sound, clean, sawn, well-seasoned timber, free from warps and loose knots and of scantings sufficiently strong for their purpose.

Construction of formwork

All formwork shall be of sufficient thickness and with joints close enough to prevent undue leakage of liquid from the concrete and fixed to proper alignment, level and plumb and supported on sufficiently strong bearers, shores, braces, plates etc. properly held together by bolts or other fastenings to prevent displacement, vibration or movement by the weight of materials, men and plant on same and so wedged and clamped as to permit easing and removal of the formwork without jarring the concrete. Where formwork is supported on previously constructed portions of the reinforced concrete structural frame, the Contractor shall by consultation with the Project Manager ensure that the supporting concrete is capable of carrying the load and/or sufficiently propped from lower floors or portions of the frame to permit the load to be temporarily carried during construction.

Soffits shall be erected with an upward camber of 5 mm for each 5 meters of horizontal span or as directed by the Project Manager.

Great care shall be taken to make and maintain all joints in the formwork as tight as possible, to prevent the leakage of grout during vibration. All faulty joints shall be caulked to the Project Manager's approval before concreting. The formwork shall be sufficiently rigid to ensure that no distortion or bulging occurs under the effects of vibration. If at any time the formwork is insufficiently rigid or in any way defective the Contractor shall strengthen or improve such formwork as the Project Manager may direct.

The Contractor's attention is drawn to the various surface textures and applied finishes required and the faces of formwork next to the concrete must be of such material and construction and be sufficiently true to provide a concrete surface which will in each particular case permit the specified surface treatment or applied finish.

All surfaces which will be in contact with concrete shall be oiled or greased to prevent adhesion of mortar. Oil or grease shall be of a non-staining mineral type applied as a thin film before the reinforcement is placed. Surplus moisture shall be removed from the forms prior to placing of the concrete.

Temporary openings shall be provided at the base of columns, wall and beam forms and at any other points where necessary to facilitate cleaning and inspection immediately before the pouring of concrete. Before the concrete is placed the shuttering shall be trued-up and any water accumulated therein shall be removed. All sawdust, nails, chips and other debris shall be washed out or otherwise removed from within the formwork. The reinforcement shall then be inspected for accuracy of fixing. Immediately before placing the concrete the formwork shall be well wetted and inspection openings shall be closed. The erection, easing, striking and removing of all formwork must be done under the personal supervision of a competent foreman, and any Damage occurring through faulty formwork or its incorrect removal shall be made good by the Contractor at his own expense.

After removal of formwork, all projections, fins etc., on the concrete surface shall be chipped off, and made good to the requirements of the Project Manager. Any voids or honeycombing shall be treated as described in "Faulty Concrete".

Stripping formwork

All formwork shall be removed without undue vibration or shock and without Damage to the concrete. No formwork shall be removed without the prior consent of the Engineer and the minimum periods that shall elapse between the placing of the concrete and the striking of the formwork will be as follows:

Beam sides, wall and columns	2 days
Slab Soffits (props left under)	3 days
Beam Soffits	7 days
Removal of props (partly subject to 7 days Concrete cube strength being satisfactory) to:	
Slabs	10 days
Beams	14 days
Cantilevered Beams and Slabs	28 days

If the Contractor wishes to take advantage of the shorter stripping times permitted for beams and slab soffits when props are left in place, he must so design his formwork that sufficient props are agreed with the

Project Manager can remain in their original positions without being moved in any way until the expiry of the minimum time for removal of props. Stripping and re-propping will not be permitted.

The above times may be reduced in certain circumstances, at the discretion of the Engineer provided an approved method is adopted at the Contractor's expense to ensure that the required concrete strength is attained before the forms are stripped.

Solid strips in composite slabs shall be considered as beams. The tops of retaining walls shall be adequately supported with stout raking props at intervals required by the Engineer. These props are not to be removed until 7 days after casting of the floor slab is over.

Supporting props to wall and beam soffits

When directed by the Project Manager, supporting props to wall and beam soffits are to be left in position until the completion of the whole of the reinforced concrete structure. The props are to be to the approval of the Engineer and the Contractor must submit the suggested method of propping to the Engineer prior to removal of formwork to the relevant surfaces.

Concrete mixes

Concrete to be used shall be of the classes specified in "Ministry of Works standard Specification" Section 17.

Class	Nominal mix	Trial Strength in N/mm ²		Where used in this Contract
		7 day	28 day	
15	1:3:6	13	19.5	Surround to pipes
25	1:2:4	25	32.5	Spillway lining, walls

Concrete mixing and placing

The concrete shall be mixed only in approved power-driven mixers of a type and capacity suitable for the work, and in any event not smaller than 0.04/0.28 c.u.m. capacity. The mixer shall be equipped with an accurate water measuring device. All materials shall be thoroughly mixed dry before water is added and the mixing of each batch shall continue for a period of not less than two minutes after the water has been added and until there is a uniform distribution of the materials and the mass is uniform in colour.

The entire contents of the mixed drum shall be discharged before recharging. The volume of mixed material shall not exceed the rated capacity of the mixer. Whenever the mixer is started, 10% extra cement shall be added to the first batch and no extra payment will be made on this account.

As a check on concrete consistency slump tests may be carried out and shall be in accordance with B.S. 1881. The Contractor shall provide the necessary apparatus and carry out such tests as are required. The slump of the concrete made with the specified water content, using dry materials, shall be determined and the water to be added under wet conditions shall be so reduced as to give approximately the same slump.

The concrete shall be mixed as near to the place where it is required as is practicable, and only as much as is required for a specified section of the work shall be mixed at one time, such sections being commenced and finished in one operation without delay. All concrete must be efficiently handled and used in the Works within twenty (20) minutes of mixing. It shall be discarded from the mixer direct either into receptacles or barrows and shall be distributed by approved means which do not cause separation or otherwise impair the quality of the concrete. Approved mechanical means of handling will be encouraged, but the use of chutes for placing concrete is subject to prior approval of the Project Manager.

Concrete shall be placed from a height not exceeding 1,500 mm directly into its permanent position and shall not be worked along the shutters to that position. Unless otherwise approved, concrete shall be placed in a single operation to the full thickness of slabs, beams, and similar members, and shall be placed in horizontal layers not exceeding 1,500 mm deep in the walls and similar members.

Concrete in columns may be placed to a height of 4 meters with careful placing and vibration and satisfactory results. Where the height of the column exceeds 4 meters suitable openings must be left in the shutters so that this maximum lift is not exceeded.

Concrete shall be placed continuously until completion of the part of the work between construction joints as specified hereinafter or of a part of the approved extent. At the completion of a specified or approved part a construction joint of the form and in the positions hereinafter specified shall be made. If stopping of concrete be unavoidable elsewhere, a construction joint shall be made where the work is stopped. A record of all such joints shall be made by the Contractor and a copy supplied to the Project Manager.

Any accumulation of set concrete on the reinforcement shall be removed by wire brushing before further concrete is placed. The Contractor shall provide runways for concreting to the satisfaction of the Project

Manager. Under no circumstances will the runways be allowed to rest on the reinforcement. Care shall be taken that the concrete is not disturbed or subjected to vibrations and shocks during the setting period. Mixing machines, platforms and barrows shall be clean before commencing mixing and be cleaned on every cessation of work. Where concrete is laid on hardcore or other absorbent materials, the base shall be suitable and sufficiently wetted before the concrete is deposited.

Works cube tests

Work cubes are to be made at intervals as required by the Project Manager in accordance with C.P. 114, and the Contractor shall provide a continuous record of the concrete work. The cubes shall be made in approved 150 mm moulds in strict accordance with the Code of Practice. Three cubes shall be made on each occasion. Each cube shall be marked with a distinguishing number (numbers) to run consecutively and the date, and a record shall be kept on site giving the following particulars:-

- a) Cube No.
- b) Date made
- c) Location in work
- d) 7-Day Test, Date, Strength
- e) 28-Day Test, Date, Strength

Cubes shall be forwarded, carriage paid, to an approved Testing Authority, in time to be tested two at 7 days and the remaining one at the discretion of the Project Manager. No cube shall be dispatched within three days of casting. Copies of all Works Cube Tests shall be forwarded to the Project Manager and one shall be retained on site. If the strengths required above are not attained and maintained during the carrying out of the contract, the Contractor will be required to increase the proportion of cement and/or substitute better aggregates so as to give concrete which does comply with the requirements of the contract. The Contractor may be required to remove and replace at his own cost any concrete which fails to attain the required strength as ascertained by Works Cube Tests.

Compaction

At all times during which the concrete is being placed, the Contractor shall provide adequate trained and experienced labour to ensure that the concrete is compacted in the forms to the satisfaction of the Project Manager. Concrete shall not be placed at a rate greater than will permit satisfactory compaction or to a depth greater than 400 mm before it is compacted.

During and immediately after placing, the concrete shall be thoroughly compacted by means of continuous tamping, spading, slicing and vibration. Vibration is required for all concrete of classes 40, 35, 25,

and 20. Care shall be taken to fill every part of the forms, to work the concrete under and around the reinforcement without displacing it to avoid disturbing recently placed concrete which has began to set. Any water accumulating on the surface of newly placed concrete shall be removed and no further concrete shall be placed thereon until such water is removed.

Internal vibrators shall be of a frequency not less than 7000 cycles per minute and shall have a rotating eccentric weight of at least 0.05 Kg. with an eccentricity of not more than 12 mm. Such vibrators shall visibly affect the concrete within a radius of 250 mm from the vibrator. Internal vibrators shall not be inserted between layers of reinforcement less than one and one half times the diameter of the vibrators apart. Contact between the vibrators and reinforcement, and vibrators and formwork shall be avoided. Internal vibrators shall be inserted vertically into the concrete at not more than 500 mm centers and shall be moved constantly from place to place. No internal vibrator shall be permitted to remain in any one position for more than ten seconds and it shall be withdrawn very slowly from the concrete.

In consolidating each layer of concrete the vibrating head shall be allowed to penetrate and re-vibrate the concrete in the upper portion of the underlying layer. In the area where newly placed concrete in each layer joins previously placed concrete more than usual vibration shall be performed, the vibrator penetrating deeply at close intervals along these contacts. Layers of concrete shall not be placed until layers previously placed have been vibrated thoroughly as specified. Vibrators shall not be used to move concrete from place to place in the formwork.

At least one internal vibrator shall be of the high frequency, low amplitude type applied with the principal direction of vibration in the horizontal plane. They shall be attached directly to the forms at no more than 1200 mm centers. In addition to internal and external vibration the upper surface of suspended floor slabs shall be leveled by tamping or vibrating to receive finishes. Vibrating elements shall be of the low frequency high amplitude type operating at a speed of not less than 3000 r.p.m.

Curing and protection

Care must be taken that no concrete is allowed to become prematurely dry and the fresh concrete must be carefully protected, within two hours of placing, from rain, sun and wind by means of Hessian sacking, polythene sheeting, or other approved means. This protective layer and the concrete itself must be kept continuously wet for at least 7 days after the concrete has been placed. The contractor will be required to provide complete coverage of all fresh concrete for a period of 7 days. Hessian or polythene sheeting shall be in the maximum widths obtainable and shall be secured against wind. The Contractor will not be permitted to use old cement bags, Hessian or other materials in small pieces.

Concrete in foundations and other underground work shall be protected from admixture with falling earth during and after placing. Traffic or loading must not be allowed on the concrete until the concrete is sufficiently matured, and in no case shall traffic or loading be of such magnitude as to cause deflection or other movement in the formwork or Damage to the concrete members. Where directed by the Project Manager props may be required to be left in position under slabs and other members for greater periods than those specified hereafter.

Faulty concrete

Any concrete which fails to comply with these specifications, or which shows signs of setting before it is placed shall be taken out and removed from site. Where concrete is found to be defective after it has set, the concrete shall be cut out and replaced in accordance with the Project Manager's instructions. On no account shall any faulty, honeycombed, or otherwise defective concrete be repaired or patched until the Project Manager has made an inspection and issued instructions for the repair. The whole cost whatsoever, which might be occasioned by the need to remove faulty concrete, shall be borne by the Contractor.

Pre-cast units

Pre-cast reinforced concrete slabs to be made to sizes as shown in the Drawings. Slabs to be cast with Grade 25 concrete in approved formwork, suitably vibrated and cured for 28 days before use.

REINFORCEMENT

Material

Reinforcement shall be as specified by the Project Manager.

Bending and placing reinforcement

Reinforcement shall be cleaned before placing and secured with space blocks in the correct position. It shall be bound with suitable wire and have such cover as shown on the drawings.

Strength of reinforcement

Characteristic strengths of reinforcement are as given in B.S. 4449, 4461, and 4483. Refer to 503.

Rod reinforcement

The steel reinforcement shall comply with the latest requirements of the following British Standards:-

Hot Rolled bars for the Reinforcement of concrete to B.S. 4449 (metric units)
Cold worked steel for the reinforcement of concrete to B.S. 4461 (metric units)

The Contractor will be required to submit a test certificate of the rollings. Reinforcement shall be stored on racks above ground level. All reinforcement shall be free from loose mill scale or rust, grease, paint or other substances likely to reduce the bond between the steel and the concrete.

BRC

The BRC should be electrically cross-welded steel wire mesh reinforcement to B.S. 4483: 1969, or as directed by the Project Manager, and of the size and weight specified in the Drawings.

The fabric shall be free from scale, dust, rust, grease or other substance likely to reduce the bond between the steel and the concrete and shall be laid with a minimum 300 mm laps and bound with No. 18 S.W.G. annealed iron wire.

Fixing reinforcement

Reinforcement shall be accurately bent to the shapes and dimensions shown on the Drawings and in accordance with B.S. 4466 (1969). Reinforcement must be cut and bent cold and no welded joints will be permitted, unless so detailed. Reinforcement shall be accurately placed as shown on the Drawings, and before and during concreting, shall be secured against displacement by using No. 18 S.W.G. annealed binding wire or suitable clips at intersections, and shall be supported by concrete or metal supports, spacers or metal hangers to ensure the correct position. No concreting shall be commenced until the Project Manager has inspected the reinforcement in position and until his approval has been obtained and Contractor has given two clear days' notice of intention to concrete.

The Contractor is responsible for maintaining the reinforcement in its correct position, according to the drawings, before and during concreting. During concreting, a competent steel fixer must be in attendance to adjust and correct the position of any reinforcement which may be displaced. The vibrators are not to come into contact with the reinforcement.

Position and correctness of reinforcement

Irrespective of whether any inspection and/or approval of the fixing of the reinforcement has been carried out as in C above, it shall be the Contractor's sole responsibility to ensure that the reinforcement

complies with the details on the Drawings and is fixed exactly in the positions shown therein and in the positions to give the prescribed cover. The Contractor will be held entirely responsible for any failure or defect in any portion of the reinforced concrete structure and including any consequent delay, claims, third party claims. etc., where it is shown that the reinforcement has been incorrectly positioned or is incorrect in size or quantity with respect to the detailed Drawings.

Concrete cover to reinforcement

Unless otherwise directed, the concrete cover to rod reinforcement over main bars in any face shall be:-

Foundations against blinding	50 mm
Strip foundations	40 mm
Columns/Floor slab	40 mm
Beams	25 mm

Projecting reinforcement

Where reinforcement projects from a concreted section of the structure and this reinforcement is expected to remain exposed for some time, it is to be coated with a cement grout to prevent rust staining on the finished concrete. This grout is to be brushed off the reinforcement prior to the continuation of concreting.

Fixtures

No openings, chases, holes or other voids shall be formed in the concrete without the prior approval of the Project Manager. Details of any fixtures to be permanently built into the concrete including the proposed position of all electrical conduits 25 mm and over in diameter shall be submitted to the Project Manager for his approval before being placed.

Chases, holes, etc., in concrete

The Contractor shall be responsible for the co-ordination with the Electrical and other Sub-Contractors for incorporating electrical conduits, pipes, fixing blocks, chases and holes in concrete members as required and must ensure that adequate notice is given to such Sub-Contractors informing them when concrete members incorporating the above are to be poured. The Contractor shall submit full details of these items to the Engineer for approval before the work is put in hand. All fixing blocks, chases, holes, etc., to be left in the concrete shall be accurately set out and cast with the concrete. Unless otherwise instructed by the Project Manager, all electrical conduit to be positioned within the reinforced concrete shall be fixed inside the steel cages of beams and columns and between the top and bottom steel layers in the slabs and similar members.

The proposed position of all electrical conduits 25 mm and over in diameter which are to be enclosed in the concrete shall be shown accurately on a plan to be submitted to the Engineer, whose approval shall be obtained before any such conduit is placed.

Specification	
----------------------	--

	<u>PARTICULAR SPECIFICATIONS</u>
--	---

A	PRICING ITEMS OF PRELIMINARIES
----------	---------------------------------------

Prices **SHALL BE INSERTED** against items of “preliminaries” in the tenderer’s priced Bills of Quantities. The contractor is advised to read and understand all preliminary items.

B	DESCRIPTION OF THE WORKS
----------	---------------------------------

The contract works include:

- Borehole drilling
- Testing pumping
- Supply and installation of solar panels and pump
- Supply and Installation of a 10,000 litre Roto tank or an equally approved plastic tank
- Fencing of borehole compound
- Construction of a water Kiosk with slab for installing water tank.

Note: All the above works should be as per the attached drawings and Bills of quantities.

	LOCATION OF THE SITE
--	-----------------------------

The site is situated in Kiseuni village, Kivaa Ward, Masinga Central Sub county in Machakos County.

	FLOOR AREAS
--	--------------------

C	
----------	--

To be done as per description in bill of quantities and technical drawings

D	MEASUREMENTS
----------	---------------------

In the event of any discrepancies arising between the Bills of Quantities and the actual works, the site measurements shall generally take precedence. However, such discrepancies between any contract documents shall immediately be referred to the PROJECT MANAGER in accordance with the Conditions of Contract. The discrepancies shall then be treated as a variation and be dealt with in accordance with the said Conditions.

	LOCATION OF SITE
--	-------------------------

E

IS AS INDICATED ELSEWHERE

F**SIGNING OF THE TENDER DOCUMENTS**

The authorized person shall append his / her signature and / or company's rubberstamp on each and every page of tender document in which entries have been made.

G**DEMOLITIONS AND ALTERATIONS**

The Contractor is to allow for all temporary protection required during the works including ordinary and special dust screens, hoardings, barriers, warning signs, etc as directed by the Project Manager and as necessary for the adequate propping and protection of existing property, finishes, workmen employed on the site, employer's agents and the public. Any damage or loss incurred due to the insufficiency of such protection must be made good by the Contractor. All protective devices are to be removed on completion of the works and any necessary making good consequent upon this is to be executed to the satisfaction of the Project Manager

The works shall be propped, strutted and supported as necessary before any alteration or demolition work commences. Prices shall include for all cleaning and preparatory work to structure and finishes and for making good to all finishes on completion whether or not specifically described.

Unless described as set aside for re-use all arising debris and surplus materials shall be carefully removed from building and cart away from site.

The Contractor shall be entirely responsible for any breakage or damage which may occur to materials required for re-use during their removal unless it is certified by the Project Manager that such damage or breakage was inevitable as a result of the condition of the item concerned

H**CLEARING AWAY**

The Contractor shall remove all temporary works, rubbish, debris and surplus materials from the site as they accumulate and upon completion of the works, remove and clear away all plant, equipment, rubbish, unused materials and stains and leave in a clean and tidy state to the reasonable satisfaction of the Project Manager.

The whole of the works shall be delivered up clean, complete and in perfect condition in every respect to the satisfaction of the Project Manager.

I CLAIMS

It shall be a condition of this contract that upon it becoming reasonably apparent to the Contractor that he has incurred losses and / or expenses due to any of the contract conditions, or by any other reason whatsoever, he shall present such a claim or intent to claim notice to the PROJECT MANAGER within the contract period. No claim shall be entertained upon the expiry of the said contract period.

J PAYMENTS

The tenderer's attention is drawn to the General Conditions of Contract and the Particular Conditions of Contract

K PREVENTION OF ACCIDENT, DAMAGE OR LOSS

The Contractor is notified that these works are to be carried out on a restricted site where the client is going on with other normal activities. The Contractor is thus instructed to take reasonable care in the execution of the works as to prevent accidents, damage or loss and disruption of activities being carried out by the Client. The Contractor shall allow in his rates any expense he deemed necessary by taking such care within the site.

L WORKING CONDITIONS

The Contractor shall allow in his rates for any interference that he may encounter in the course of the works for the Client may in some cases ask the Contractor not to proceed with the works until some activities within the site are completed, as the facility will be operating as usual during the course of the contract.

M SIGNBOARD

Allow for providing, erecting, maintaining throughout the course of the Contract and afterwards clearing away a signboard as designed, specified and approved by the Project Manager.

N LABOUR CAMPS

The Contractor shall be allowed to house labour on site

O MATERIALS FROM DEMOLITIONS

Any materials arising from demolitions and not re-used shall become the property of the Client.

P PRICING RATES

The tenderer shall include for all costs in executing the whole of the works, including transport, replacing damaged items, fixing, all to comply with the said Conditions of Contract.

Q SECURITY

The Contractor shall allow for providing adequate security for the works and the workers in the course of execution of this contract. No claim will be entertained from the Contractor for not maintaining adequate security for both the works and workers.

R URGENCY OF THE WORKS

The Contractor is notified that these “**works are urgent**” and should be completed within the period stated in these Particular Preliminaries.

The Contractor shall allow in his rates for any costs he/ she deems that he/ she may incur by having to complete these works within the stipulated contract period.

S PAYMENT FOR MATERIALS ON SITE

All materials for incorporation in the works must be stored on site before payment is effected, unless specifically exempted by the Project Manager. This is to include materials of the Contractor, nominated sub-Contractors and nominated suppliers.

T EXISTING SERVICES

Prior to the commencement of any work, the Contractor is to ascertain from the relevant authority the exact position, depth and level of all existing services in the area and he/she shall make whatever provisions may be required by the authorities concerned for the support, maintenance and protection of such services.

U CONTRACT COMPLETION PERIOD

The contract completion period in accordance with clause 31 of the Conditions of Contract must be adhered to.

The '**PROJECT MANAGER**' shall strictly monitor the Contractors progress in relation to the progress chart and should it be found necessary the '**PROJECT MANAGER**' shall inform the Contractor in writing that his actual performance on site is not satisfactory .In all such cases the Contractor shall accelerate his rate of performance production and progress by all means such as additional labour, plant, e.t.c and working overtime all at his cost.

V PERFORMANCE BOND

A guarantee of 10 % of the contract sum will be required in accordance. No payment on account for the works executed will be made to the contractor until he has submitted the Performance guarantee to the Project Manager duly signed, sealed and stamped from an approved Bank.

W DELIVERY OF TENDER

Tenders and all documents in connection therewith, as specified above must be delivered in the addressed envelope which should be properly sealed and deposited at the offices as specified in the letter accompanying these documents or as indicated in the advertisement.

Tenders will be opened at the time specified in the letter accompanying these Tender Documents or as indicated in the advertisement. Tenders delivered/received later than the above time will not be opened.

X VALUE ADDED TAX

The Contractor's attention is drawn to the Legal Notice in the Finance Act part 3 Section 21(b) operative from 1st September, 1993 which requires payment of VAT on all contracts. The Contractor should therefore include allowance in his rates and prices for prices for VAT and any other Government taxes currently in force.

ITEM	DESCRIPTION																				
-	<p data-bbox="337 241 789 275">GENERAL PRELIMINARIES</p> <p data-bbox="215 325 1252 359">A. PRICING ITEMS OF PRELIMINARIES AND PREAMBLES</p> <p data-bbox="337 415 1450 485">Prices will be inserted against items of Preliminaries in the Contractor's priced Bills of Quantities and Specification.</p> <p data-bbox="337 548 1450 695">The Contractor shall be deemed to have included in his prices or rates for the various items in the Bills of Quantities or Specification for all costs involved in complying with all the requirements for the proper execution of the whole of the works in the Contract.</p> <p data-bbox="215 745 626 779">B. ABBREVIATIONS</p> <p data-bbox="337 842 1450 947">Throughout these Bills, units of measurement and terms are abbreviated and shall be all the requirements for the proper execution of the whole of the works in the Contract.</p> <table data-bbox="337 955 1084 1528"> <tr> <td data-bbox="344 955 402 989"><i>Ha</i></td> <td data-bbox="695 955 1008 989">Shall mean hectares</td> </tr> <tr> <td data-bbox="337 997 412 1031"><i>C.M.</i></td> <td data-bbox="695 997 1062 1031">Shall mean cubic metre</td> </tr> <tr> <td data-bbox="337 1081 412 1115"><i>S.M.</i></td> <td data-bbox="695 1081 1084 1115">Shall mean square metre</td> </tr> <tr> <td data-bbox="337 1165 412 1199"><i>L.M.</i></td> <td data-bbox="695 1165 1062 1199">Shall mean linear metre</td> </tr> <tr> <td data-bbox="337 1249 402 1283"><i>MM</i></td> <td data-bbox="701 1249 1045 1283">Shall mean Millimetre</td> </tr> <tr> <td data-bbox="337 1333 396 1367"><i>Kg.</i></td> <td data-bbox="695 1333 1068 1367">Shall mean Kilogramme</td> </tr> <tr> <td data-bbox="337 1417 396 1451"><i>No.</i></td> <td data-bbox="695 1417 1008 1451">Shall mean Number</td> </tr> <tr> <td data-bbox="337 1501 402 1535"><i>Prs.</i></td> <td data-bbox="672 1501 938 1535">Shall mean Pairs</td> </tr> </table> <p data-bbox="337 1543 1450 1612"><i>B.S.</i> - Shall mean the British Standard Specification Published by the British Standards Institution, 2 Park Street, London W.I., England.</p> <p data-bbox="337 1675 1450 1745"><i>Ditto</i> - Shall mean the whole of the preceding description except as qualified in the description in which it occurs.</p> <table data-bbox="337 1795 1214 1902"> <tr> <td data-bbox="337 1795 402 1829"><i>m.s.</i></td> <td data-bbox="701 1795 1214 1829">Shall mean measured separately.</td> </tr> <tr> <td data-bbox="337 1879 423 1913"><i>a.b.d</i></td> <td data-bbox="701 1879 1198 1913">Shall mean as before described.</td> </tr> </table>	<i>Ha</i>	Shall mean hectares	<i>C.M.</i>	Shall mean cubic metre	<i>S.M.</i>	Shall mean square metre	<i>L.M.</i>	Shall mean linear metre	<i>MM</i>	Shall mean Millimetre	<i>Kg.</i>	Shall mean Kilogramme	<i>No.</i>	Shall mean Number	<i>Prs.</i>	Shall mean Pairs	<i>m.s.</i>	Shall mean measured separately.	<i>a.b.d</i>	Shall mean as before described.
<i>Ha</i>	Shall mean hectares																				
<i>C.M.</i>	Shall mean cubic metre																				
<i>S.M.</i>	Shall mean square metre																				
<i>L.M.</i>	Shall mean linear metre																				
<i>MM</i>	Shall mean Millimetre																				
<i>Kg.</i>	Shall mean Kilogramme																				
<i>No.</i>	Shall mean Number																				
<i>Prs.</i>	Shall mean Pairs																				
<i>m.s.</i>	Shall mean measured separately.																				
<i>a.b.d</i>	Shall mean as before described.																				

<p>A.</p>	<p>EXCEPTION TO THE STANDARD METHOD OF MEASUREMENT</p> <p><i>Attendance</i> ; Clause B19(a) of the Standard Method of Measurement is deleted and the following clause is substituted:-</p> <p>Attendance on nominated Sub-Contractors shall be given as an item in each case shall be deemed to include: allowing use of standing scaffolding, mess rooms, sanitary accommodation and welfare facilities; provision of special scaffolding where necessary; providing space for office accommodation and for storage of plant and materials; providing light and water for their work: clearing away rubbish; unloading checking and hoisting: providing electric power and removing and replacing duct covers, pipe casings and the like necessary for the execution and testing of Sub- Contractors' work and being responsible for the accuracy of the same.</p> <p><i>Fix Only</i>:-</p> <p>"Fix Only" shall mean take delivery at nearest railway station (Unless otherwise stated),pay all demurrage charges, load and transport to site where necessary, unload, store, unpack, assemble as necessary, distribute to position, hoist and fix only.</p>
<p>B.</p>	<p>EMPLOYER</p>
<p></p>	<p>As defined in the conditions of contract</p>
<p>C.</p>	<p>PROJECT MANAGER</p>
<p></p>	<p>The term "P.M." wherever used in these Bills of Quantities shall be deemed to imply the Project Manager as defined in of the Conditions of Contract or such person or persons as may be duly authorised to represent him on behalf of the Government.</p>
<p>D.</p>	<p>ARCHITECT</p>
<p></p>	<p>The term "Architect" shall be deemed to mean "The P.M." as defined above</p>
<p>A</p>	<p>QUANTITY SURVEYOR</p>

The term "Quantity Surveyor" shall be deemed to mean "The P.M." as defined above.

B ELECTRICAL ENGINEER

The term "Electrical Engineer" shall be deemed to mean "The P.M." as defined above

C MECHANICAL ENGINEER

The term "Mechanical Engineer" shall be deemed to mean "The P.M." as defined

D STRUCTURAL ENGINEER

The term "Structural Engineer" shall be deemed to mean "The P.M." as defined above

-
Particulars of insertions to be made in the Appendix to the Contract Agreement will be found in the Particular Preliminaries part of these Bills of Quantities

A BOND.

The Contractor shall find and submit on the Form of Tender as given in the instructions to bid and SPN

B PLANT, TOOLS AND VEHICLES

Allow for providing all scaffolding, plant, tools and vehicles required for the works except in so far as may be stated otherwise herein and except for such items specifically and only required for the use of nominated Sub-Contractors as described herein. No timber used for scaffolding, formwork or temporary works of any kind shall be used afterwards in the permanent work.

C TRANSPORT.

Allow for transport of workmen, materials, etc., to and from the site at such hours and by such routes as may be permitted by the competent authorities.

D MATERIALS AND WORKMANSHIP.

All materials and workmanship used in the execution of the work shall be of the best quality and description unless otherwise stated. The Contractor shall order all materials to be obtained from overseas immediately after the Contract is signed and shall also ensure they are onsite when required for use in the works. The Bills of Quantities shall not be used for the purpose of ordering materials.

E SIGN FOR MATERIALS SUPPLIED.

The Contractor will be required to sign a receipt for all articles and materials supplied by the **PROJECT MANAGER** at the time of taking deliver thereof, as having received them in good order and condition, and will thereafter be responsible for any loss or damage and for replacements of any such loss or damage with articles and/or materials which will be supplied by the **PROJECT MANAGER** at the current market prices including Customs Duty and V.A.T., all at the Contractor's own cost and expense, to the satisfaction of the **PROJECT MANAGER**

A STORAGE OF MATERIALS

The Contractor shall provide at his own risk and cost where directed on the site weather proof lock-up sheds and make good damaged or disturbed surfaces upon completion to the satisfaction of the **PROJECT MANAGER** Nominated Sub-Contractors are to be made liable for the cost of any storage accommodation provided especially for their use.

B SAMPLES

The Contractor shall furnish at his own cost any samples of materials or workmanship including concrete test cubes required for the works that may be called for by the **PROJECT MANAGER** for his approval until such samples are approved by the **PROJECT MANAGER** and the **PROJECT MANAGER**, may reject any materials or workmanship not in his opinion to be up to approved samples. The **PROJECT MANAGER** shall arrange for the testing of such materials as he may at his discretion deem desirable, but the testing shall be made at the expense of the Contractor and not at the expense of the **PROJECT MANAGER**. The Contractor shall pay for the testing in accordance with the current scale of testing charges laid down by the Ministry of Roads, Housing and Public Works.

The procedure for submitting samples of materials for testing and the method of marking for identification shall be as laid down by the **PROJECT MANAGER** The Contractor shall allow in his tender for such samples and tests except those in connection with nominated sub-contractors' work.

C GOVERNMENT ACTS REGARDING WORK PEOPLE ETC.

Allow for complying with all Government Acts, Orders and Regulations in connection with the employment of Labour and other matters related to the execution of the works. In particular the Contractor's attention is drawn to the provisions of the Factory Act 1950 and his tender must include for all costs arising or resulting from compliance with any Act, Order or Regulation relating to Insurances, pensions and holidays for workpeople or so the safety, health and welfare of the workpeople.

The Contractor must make himself fully acquainted with current Acts and Regulations, including Police Regulations regarding the movement, housing, security and control of labour, labour camps , passes for transport, etc. It is most important that the Contractor, before tendering, shall obtain from the relevant Authority the fullest information regarding all such regulations and/or restrictions which may affect the organisation of the works, supply and control of labour, etc., and allow accordingly in his tender. No claim in respect of want of knowledge in this connection will be entertained.

A SECURITY OF WORKS ETC.

The Contractor shall be entirely responsible for the security of all the works stores, materials, plant, personnel, etc., both his own and sub-contractors' and must provide all necessary watching, lighting and other precautions as necessary to ensure security against theft, loss or damage and the protection of the public.

B PUBLIC AND PRIVATE ROADS.

Maintain as required throughout the execution of the works and make good any damage to public or private roads arising from or consequent upon the execution of the works to the satisfaction of the local and other competent authority and the **PROJECT MANAGER**

C EXISTING PROPERTY.

The Contractor shall take every precaution to avoid damage to all existing property including roads, cables, drains and other services and he will be held responsible for and shall make good all such damage arising from the execution of this contract at his own expense to the satisfaction of the **PROJECT MANAGER**

<p>D</p>	<p>VISIT SITE AND EXAMINE DRAWINGS.</p> <p>The Contractor is recommended to examine the drawings and visit the site the location of which is described in the Particular Preliminaries hereof. He shall be deemed to have acquainted himself therewith as to its nature, position, means of access or any other matter which, may affect his tender. No claim arising from his failure to comply with this recommendation will be considered.</p>
<p>E</p>	<p>ACCESS TO SITE AND TEMPORARY ROADS.</p> <p>Means of access to the Site shall be agreed with the PROJECT MANAGER prior to commencement of the work and Contractor must allow for building any necessary temporary access roads for the transport of the materials, plant and workmen as may be required for the complete execution of the works including the provision of temporary culverts, crossings, bridges, or any other means of gaining access to the Site. Upon completion of the works, the Contractor shall remove such temporary access roads; temporary culverts, bridges, etc., and make good and reinstate all works and surfaces disturbed to the satisfaction of the PROJECT MANAGER The Contractor should also allow for relocating existing fence (approx. 30 metres long).</p>
<p>A</p>	<p>AREA TO BE OCCUPIED BY THE CONTRACTOR</p> <p>The area of the site which may be occupied by the Contractor for use of storage and for the purpose of erecting workshops, etc., shall be defined on site by the PROJECT MANAGER.</p>
<p>B</p>	<p>OFFICE ETC. FOR THE PROJECT MANAGER</p> <p>The Contractor shall provide, erect and maintain where directed on site and afterwards dismantle the site office of the standard type, complete with furniture. He shall also provide a strong metal trunk complete with strong hasp and staple fastening and two keys. He shall provide, erect and maintain a lock-up type water or bucket closet for the sole use of the PROJECT MANAGER including making temporary connections to the drain where applicable to the satisfaction of Government and Medical Officer of Health and shall provide services of cleaner and pay all conservancy charges and keep both office and closet in a clean and sanitary condition from commencement to the completion of the works and dismantle and make good disturbed surfaces. The office and closet</p>

	<p>shall be completed before the Contractor is permitted to commence the works. The Contractor shall make available on the Site as and when required by the "PROJECT MANAGER" a modern and accurate level together with leveling staff, ranging rods and 50 metre metallic or linen tape.</p> <p>C WATER AND ELECTRICITY SUPPLY FOR THE WORKS</p> <p>The Contractor shall provide at his own risk and cost all necessary water, electric light and power required for use in the works. The Contractor must make his own arrangements for connection to the nearest suitable water main and for metering the water used. He must also provide temporary tanks and meters as required at his own cost and clear away when no longer required and make good on completion to the entire satisfaction of the PROJECT MANAGER. The Contractor shall pay all charges in connection herewith. No guarantee is given or implied that sufficient water will be available from mains and the Contractor must make his own arrangements for augmenting this supply at his own cost. Nominated Sub--contractors are to be made liable for the cost of any water or electric current used and for any installation provided especially for their own use.</p> <p>D SANITATION OF THE WORKS</p> <p>The Sanitation of the works shall be arranged and maintained by the Contractor to the satisfaction of the Government and/or Local Authorities, Labour Department and the PROJECT MANAGER.</p>
<p>A</p>	<p>SUPERVISION AND WORKING HOURS</p> <p>The works shall be executed under the direction and to the entire satisfaction in all respects of the PROJECT MANAGER who shall at all times during normal working hours have access to the works and to the yards and workshops of the Contractor and sub-Contractors or other places where work is being prepared for the contract.</p>
<p>B</p>	<p>PROVISIONAL SUMS.</p> <p>The term "Provisional Sum" wherever used in these Bills of Quantities shall have the meaning stated in Section A item A7(i) of the Standard</p>

	<p>Method of Measurement. Such sums are net and no addition shall be made to them for profit.</p> <p>C PRIME COST (OR P.C.) SUMS.</p> <p>The term "Prime Cost Sum" or "P.C. Sum" wherever used in these Bills of Quantities shall have the meaning stated in Section A item A7 (ii) of the Standard Method of Measurement. Persons or firms nominated by the PROJECT MANAGER to execute work or to provide and fix materials or goods are described herein as Nominated Sub-Contractors. Persons or firms so nominated to supply goods or materials are described herein as Nominated Suppliers.</p> <p>D PROGRESS CHART.</p> <p>The Contractor shall provide within two weeks of Possession of Site and in agreement with the PROJECT MANAGER a Progress Chart for the whole of the works including the works of Nominated Sub-Contractors; one copy to be handed to the PROJECT MANAGER and a further copy to be retained on Site. Progress to be recorded and chart to be amended as necessary as the work proceeds.</p> <p>C. ADJUSTMENT OF P.C. SUMS.</p> <p>In the final account all P.C. Sums shall be deducted and the amount properly expended upon the PROJECT MANAGER'S order in respect of each of them added to the Contract sum. The Contractor shall produce to the PROJECT MANAGER such quotations, invoices or bills, properly receipted, as may be necessary to show the actual details of the sums paid by the Contractor. Items of profit upon P.C. Sums shall be adjusted in the final account pro-rata to the amount paid. Items of "attendance"</p>
<p>A</p>	<p>ADJUSTMENT OF P.C. SUMS. Ctd.....</p> <p>Should the Contractor be permitted to tender and his tender be accepted of any work for which a P.C. Sum is included in these Bill of Quantities profit and attendance will be allowed at the same rate as it would be if the work were executed by a Nominated Sub-Contractor.</p>
<p>B</p>	<p>ADJUSTMENT OF PROVISIONAL SUMS.</p>

<p>C</p>	<p>In the final account all Provisional Sums shall be deducted and the value of the work properly executed in respect of them upon the PROJECT MANAGER's order added to the Contract Sum. Such work shall be valued as described for Variations, but should any part of the work be executed by a Nominated Sub-Contractor, the value of such work or articles for the work to be supplied by a Nominated Supplier, the value of such work or articles shall be treated as a P.C. Sum and profit and attendance comparable to that contained in the priced Bills of Quantities for similar items added.</p> <p>NOMINATED SUB-CONTRACTORS</p> <p>When any work is ordered by the PROJECT MANAGER to be executed by nominated sub-contractors, the Contractor shall enter into sub-contracts and shall thereafter be responsible for such sub-contractors in every respect. Unless otherwise described the Contractor is to provide for such Sub-Contractors any or all of the facilities described in these Preliminaries. The Contractor should price for these with the nominated Sub-contract Contractor's work concerned in the P.C. Sums under the description "add for Attendance".</p>
<p>D</p>	<p>DIRECT CONTRACTS</p> <p>Notwithstanding the foregoing conditions, the Government reserves the right to place a "Direct Contract" for any goods or services required in the works which are covered by a P.C. Sum in the Bills of Quantities and to pay for the same direct. In any such instances, profit relative to the P.C. Sum the priced Bills of Quantities will be adjusted as described for P.C. Sums and allowed.</p>
<p>A</p>	<p>ATTENDANCE UPON OTHER TRADESMEN, ETC.</p> <p>The Contractor shall allow for the attendance of trade upon trade and shall afford any tradesmen or other persons employed for the execution of any work not included in this Contract every facility for carrying out their work and also for use of his ordinary scaffolding. The Contractor, however, shall not be required to erect any special scaffolding for them. The Contractor shall perform such cutting away for and making good after the work of such tradesmen or persons as may be ordered by the PROJECT MANAGER and the work will be measured and paid for to the extent executed at rates provided in these Bills.</p>
<p>B</p>	<p>INSURANCE</p>

<p>C</p>	<p>The Contractor shall insure as required in the Conditions of Contract. No payment on account of the work executed will be made to the Contractor until he has satisfied the PROJECT MANAGER either by production of an Insurance Policy or and Insurance Certificate that the provision of the foregoing Insurance Clauses have been complied with in all respects. Thereafter the PROJECT MANAGER shall from time to time ascertain that premiums are duly paid up by the Contractor who shall if called upon to do so, produce the receipted premium renewals for the PROJECT MANAGER's inspection.</p> <p>PROVISIONAL WORK</p> <p>All work described as "Provisional" in these Bills of Quantities is subject to remeasurement in order to ascertain the actual quantity executed for which payment will be made. All "Provisional" and other work liable to adjustment under this Contract shall left uncovered for a reasonable time to allow all measurements needed for such adjustment to be taken by the PROJECT MANAGER Immediately the work is ready for measuring, the Contractor shall give notice to the PROJECT MANAGER. If the Contractor makes default in these respects he shall if the PROJECT MANAGER so directs uncover the work to enable all measurements to be taken and afterwards reinstate at his own expense.</p> <p>D</p> <p>ALTERATIONS TO BILLS, PRICING, ETC.</p> <p>Any unauthorised alteration or qualification made to the text of the Bills of Quantities may cause the Tender to be disqualified and will in any case be ignored. The Contractor shall be deemed to have made allowance in his prices generally to cover any items against which no price has been inserted in the priced Bills of Quantities. All items of measured work shall be priced in detail and the Tenders containing Lump Sums to cover trades or groups of work must be broken down to show the price of each item before they will be accepted.</p>
<p>A</p>	<p>BLASTING OPERATIONS</p> <p>Blasting will only be allowed with the express permission of the PROJECT MANAGER in writing. All blasting operations shall be carried out at the Contractor's sole risk and cost in accordance with any Government regulations in force for the time being, and any special regulations laid down by the PROJECT MANAGER governing the use and storage of explosives.</p>
<p>B</p>	<p>MATERIALS ARISING FROM EXCAVATIONS</p>

	<p>Materials of any kind obtained from the excavations shall be the property of the Government. Unless the PROJECT MANAGER directs otherwise such materials shall be dealt with as provided in the Contract. Such materials shall only be used in the works, in substitution of materials which the Contractor would otherwise have had to supply with the written permission of the PROJECT MANAGER. Should such permission be given, the Contractor shall make due allowance for the value of the materials so used at a price to be agreed.</p>
C	<p>PROTECTION OF THE WORKS.</p> <p>Provide protection of the whole of the works contained in the Bills of Quantities, including casing, casing up, covering or such other means as may be necessary to avoid damage to the satisfaction of the PROJECT MANAGER and remove such protection when no longer required and make good any damage which may nevertheless have been done at completion free of cost to the Government.</p>
D	<p>REMOVAL OF RUBBISH ETC.</p> <p>Removal of rubbish and debris from the Buildings and site as it accumulates and at the completion of the works and remove all plant, scaffolding and unused materials at completion.</p>
E	<p>WORKS TO BE DELIVERED UP CLEAN</p> <p>Clean and flush all gutters, rainwater and waste pipes, manholes and drains, wash (except where such treatment might cause damage) and clean all floors, sanitary fittings, glass inside and outside and any other parts of the works and remove all marks, blemishes, stains and defects from joinery, fittings and decorated surfaces generally, polish door furniture and bright parts of metalwork and leave the whole of the buildings watertight, clean, perfect and fit for occupation to the approval of the PROJECT MANAGER</p>
A.	<p>GENERAL SPECIFICATION.</p> <p>For the full description of materials and workmanship, method of execution of the work and notes for pricing, the Contractor is referred to the Ministry of Roads, Public Works and Housing General Specification dated 1976 or any subsequent revision thereof which is issued as a separate document, and which shall be allowed in all</p>

respects unless it conflicts with the General Preliminaries, Trade Preambles or other items in these Bills of Quantities.

B. MATERIALS ON SITE

All materials for incorporation in the works must be stored on or adjacent to the site before payment is effected unless specifically exempted by the **PROJECT MANAGER**. This includes the materials of the Main Contractor, Nominated Sub-Contractors and Nominated Suppliers.

C. HOARDING

The Contractor shall enclose all the site under construction with a hoarding 2400 mm high consisting of iron sheets gauge 30 on 100 x 50 mm 2nd grade treated sawn cypress timber posts firmly secured at 1800 mm centres with two 75 x 50 mm 2nd grade treated sawn cypress timber rails. The Contractor is in addition required to take all precautions necessary for the safe custody of the works, materials, plant, public and Employer's property on the site.

E. CONTRACTOR'S SUPERINTENDENCE/SITE AGENT

The Contractor shall constantly keep on the works a literate English speaking Agent or Representative, competent and experienced in the kind of work involved who shall give his whole experience in the kind of work involved and shall give his whole time to the superintendence of the works. Such Agent or Representative shall receive on behalf of the Contractor all directions and instructions from the Project Manager and such directions shall be deemed to have been given to the Contractor in accordance with the Conditions of Contract.

Drawings

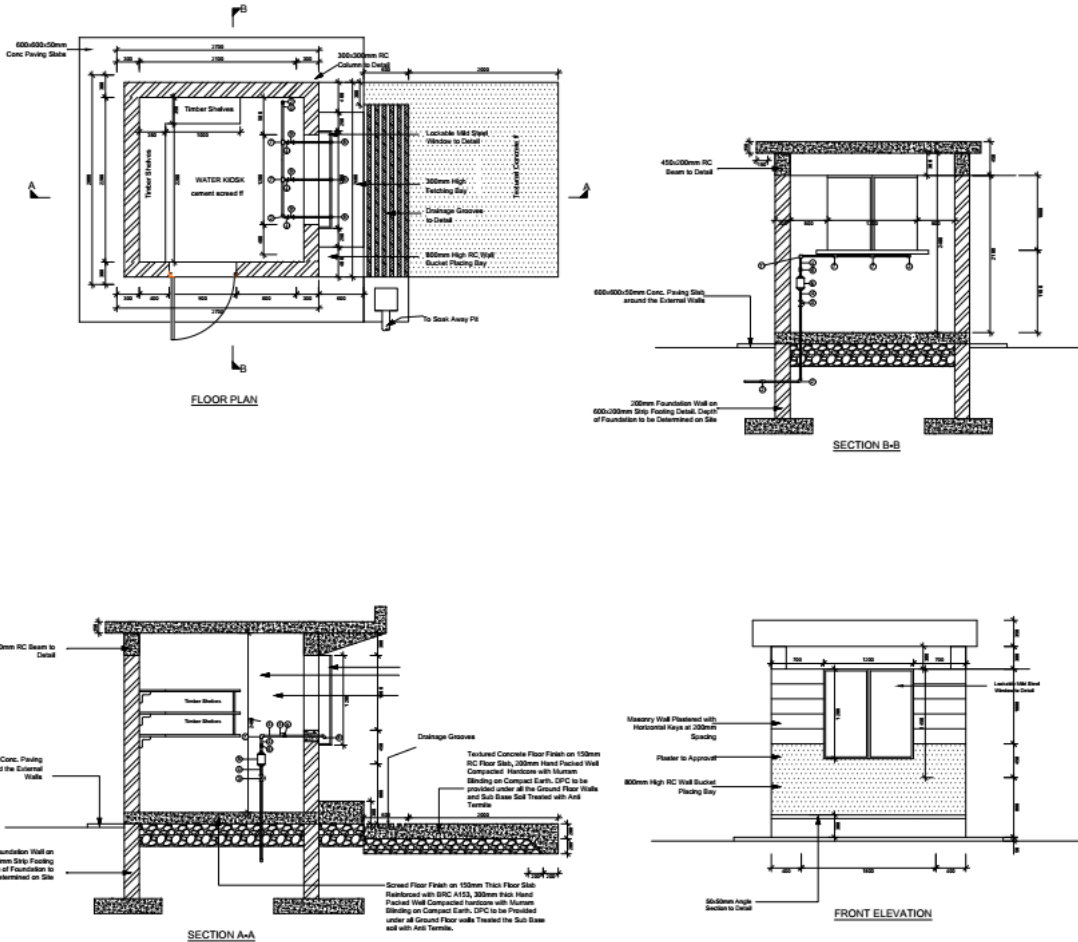

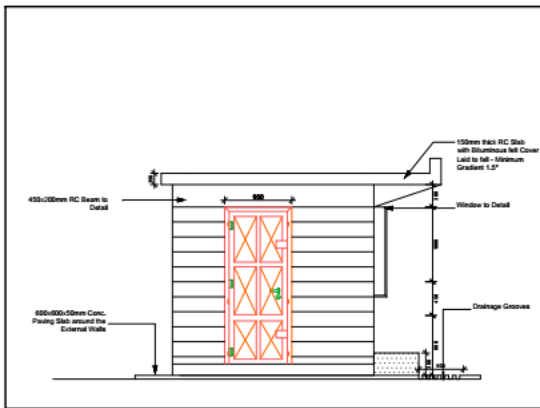

SIDE ELEVATION

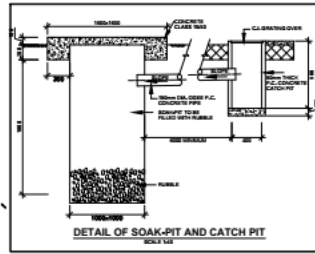

DETAIL OF SOAK-PIT AND CATCH PIT

SCHEDULE OF FITTINGS

ITEM Nr	DESCRIPTION	UNIT	QUANTITY
1	25mm Dia GI Union	Nr	3
2	25mm Dia GI Elbow	Nr	3
3	25mm Dia Gate Valve (PEGLER)	Nr	2
4	25mm Dia GI Nipple	Nr	11
5	25mm Dia GI Water Meter (NENT)	Nr	1
6	25mm Dia Non Return Valve	Nr	1
7	25mm Dia GI Tee	Nr	5
8	25mm Dia GI Bend	Nr	4
9	25mm Dia Ball Cock Water Tap	Nr	3
10	25mm Dia GI Long Threaded Nipple	Nr	2
11	25mm Dia GI Back Nut	Nr	4
12	25mm Dia GI Clean G Pipe	Nr	4
13	Roze White 40kg	Nr	3
14	Temp Thread	LSM	2

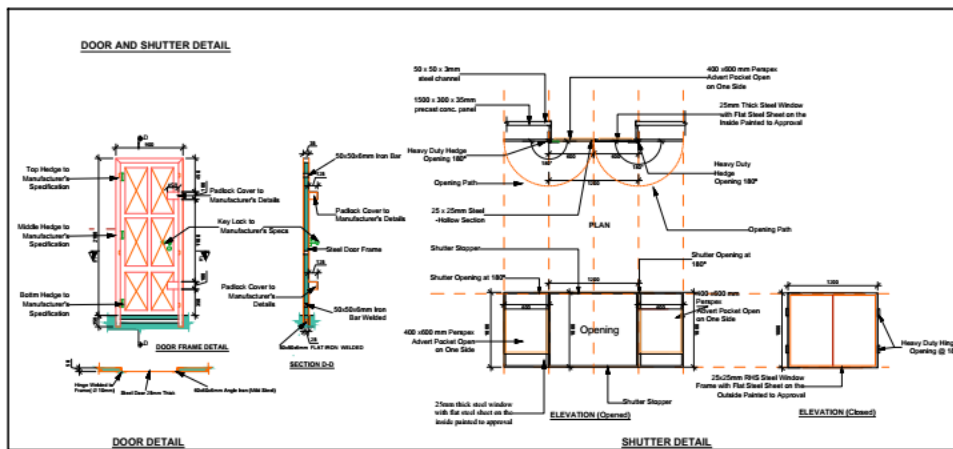

DOOR DETAIL

SHUTTER DETAIL

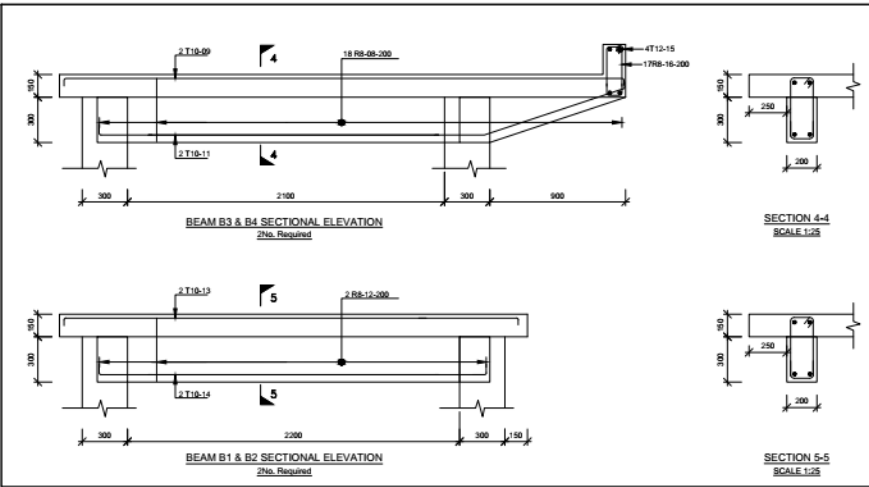
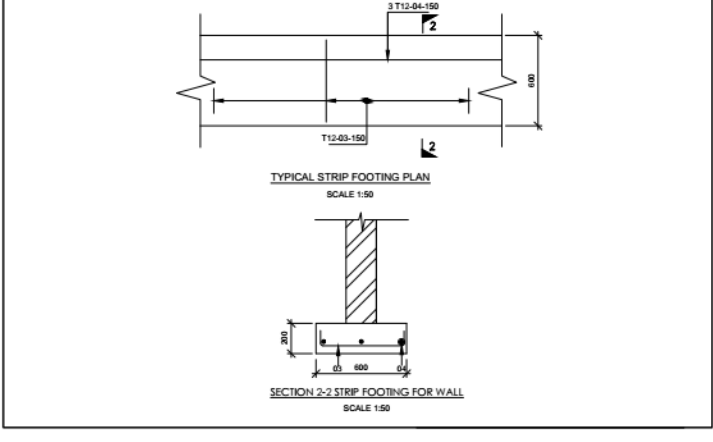
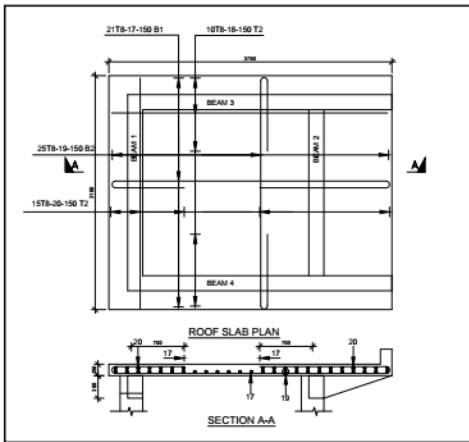

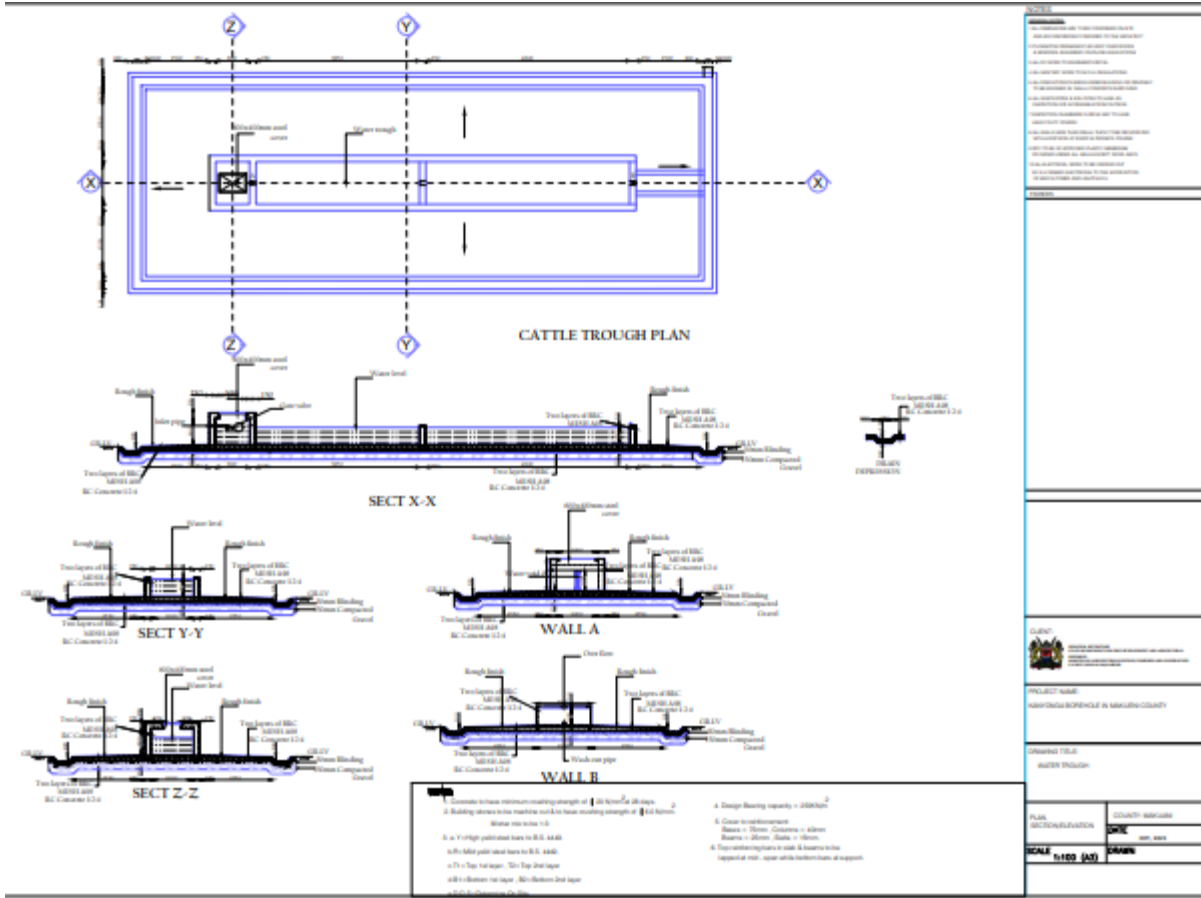

<p>REVISIONS</p> <p>1. Add notes for construction of the trough 2. Add notes for construction of the trough 3. Add notes for construction of the trough 4. Add notes for construction of the trough 5. Add notes for construction of the trough 6. Add notes for construction of the trough 7. Add notes for construction of the trough 8. Add notes for construction of the trough 9. Add notes for construction of the trough 10. Add notes for construction of the trough</p>				
<p>DATE</p> <p>11/11/2011</p>				
<p>PROJECT NAME</p> <p>CATTLE TROUGH IN MARICOPA COUNTY</p>				
<p>PROJECT TITLE</p> <p>ARCHITECTURE</p>				
<table border="1" style="width: 100%; border-collapse: collapse;"> <tr> <td style="padding: 2px;">TITLE</td> <td style="padding: 2px;">COUNTY MARICOPA</td> </tr> <tr> <td style="padding: 2px;">SCALE</td> <td style="padding: 2px;">1/8" = 1'-0" (AS)</td> </tr> </table>	TITLE	COUNTY MARICOPA	SCALE	1/8" = 1'-0" (AS)
TITLE	COUNTY MARICOPA			
SCALE	1/8" = 1'-0" (AS)			

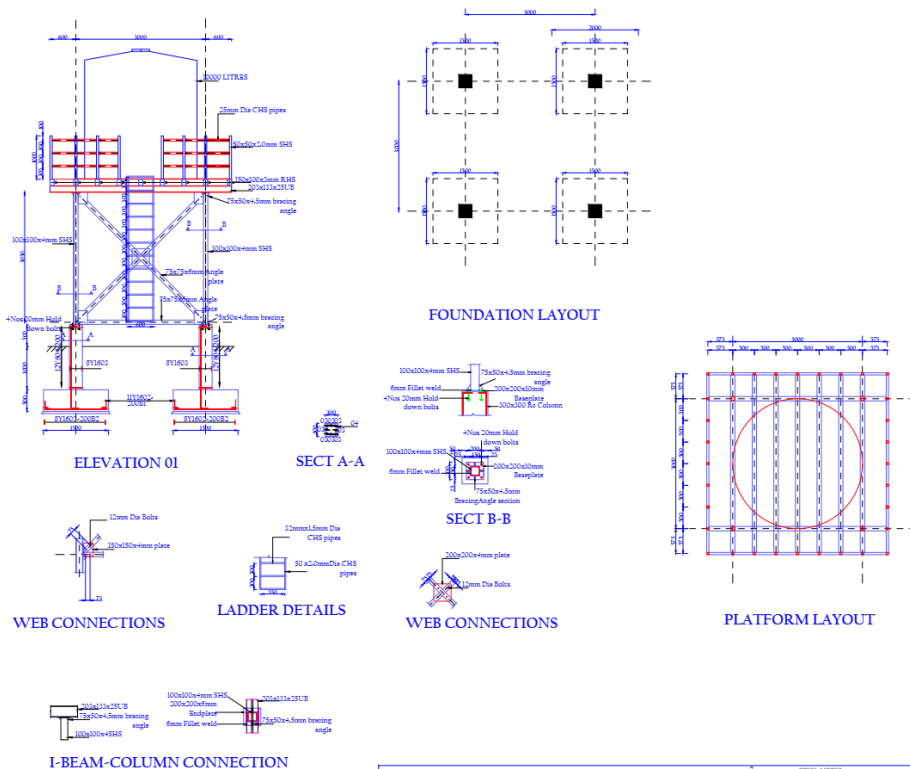

NOTES

GENERAL NOTES

1. ALL DIMENSIONS ARE TO BE DIMENSIONS UNLESS OTHERWISE SPECIFIED.
2. ALL DIMENSIONS ARE TO BE DIMENSIONS UNLESS OTHERWISE SPECIFIED.
3. ALL DIMENSIONS ARE TO BE DIMENSIONS UNLESS OTHERWISE SPECIFIED.
4. ALL DIMENSIONS ARE TO BE DIMENSIONS UNLESS OTHERWISE SPECIFIED.
5. ALL DIMENSIONS ARE TO BE DIMENSIONS UNLESS OTHERWISE SPECIFIED.
6. ALL DIMENSIONS ARE TO BE DIMENSIONS UNLESS OTHERWISE SPECIFIED.
7. ALL DIMENSIONS ARE TO BE DIMENSIONS UNLESS OTHERWISE SPECIFIED.
8. ALL DIMENSIONS ARE TO BE DIMENSIONS UNLESS OTHERWISE SPECIFIED.
9. ALL DIMENSIONS ARE TO BE DIMENSIONS UNLESS OTHERWISE SPECIFIED.
10. ALL DIMENSIONS ARE TO BE DIMENSIONS UNLESS OTHERWISE SPECIFIED.

FINISHES

- EXTERNAL WALLS - UNPAINTED STEEL/PALLET FINISH
- INTERNAL WALLS - UNPAINTED STEEL/PALLET FINISH
- FLOORING - UNPAINTED STEEL/PALLET FINISH
- ROOFING - UNPAINTED STEEL/PALLET FINISH
- DOORS - UNPAINTED STEEL/PALLET FINISH

CLIENT:
 PRINCIPAL SECRETARY MINISTRY OF AGRICULTURE, LIVESTOCK AND FISHERIES
 P.O. BOX 30023-00100 NAIROBI

PROJECT NAME:
 PROPOSED DRILLING/DEVELOPMENT OF CHEPCHOUGH COMMUNITY BOREHOLE

ON PLOT LR. NO. ...

PROJECT TITLE:
 WATER TANK PLATFORM

NOTES

1. Concrete to have minimum curing strength of 4.23 N/mm^2 at 28 days.
2. Building stones to be machine cut & to have curing strength of 4.6 N/mm^2 .
3. a. Vertical yield strength to B.S. 4448. b. σ_{11} = Mid yield steel bars to B.S. 4448. c. σ_{12} = Top 1st layer, σ_{13} = Top 2nd layer. d. σ_{21} = Bottom 1st layer, σ_{22} = Bottom 2nd layer. e. D.O.S = Determine On Site.
4. Design Bearing capacity = 250 kN/m^2 .
5. Cover to reinforcement: Slabs = 25mm, Columns = 40mm, Beams = 25mm, Stairs = 25mm.
6. Top reinforcing bars in slab & beams to be lapped at mid-span while bottom bars at support.

STEEL NOTES

1. All structural steel to be to grade 43.
2. All bolts to be 12mm M.C. with washers unless shown otherwise.
3. All dimensions to be confirmed on site before fabrication.
4. All welds to be done (fillet welds) unless otherwise specified.
5. Shop drawings are to be submitted to the engineer for approval.
6. Apply two coats of red oxide primer.

PLAN	SECTION/ELEVATION	COUNTY	WEST POKOT
SCALE	1:100 (A3)	DATE	JUN 2015
		DRAWN	skd
		DRWG	03
			1

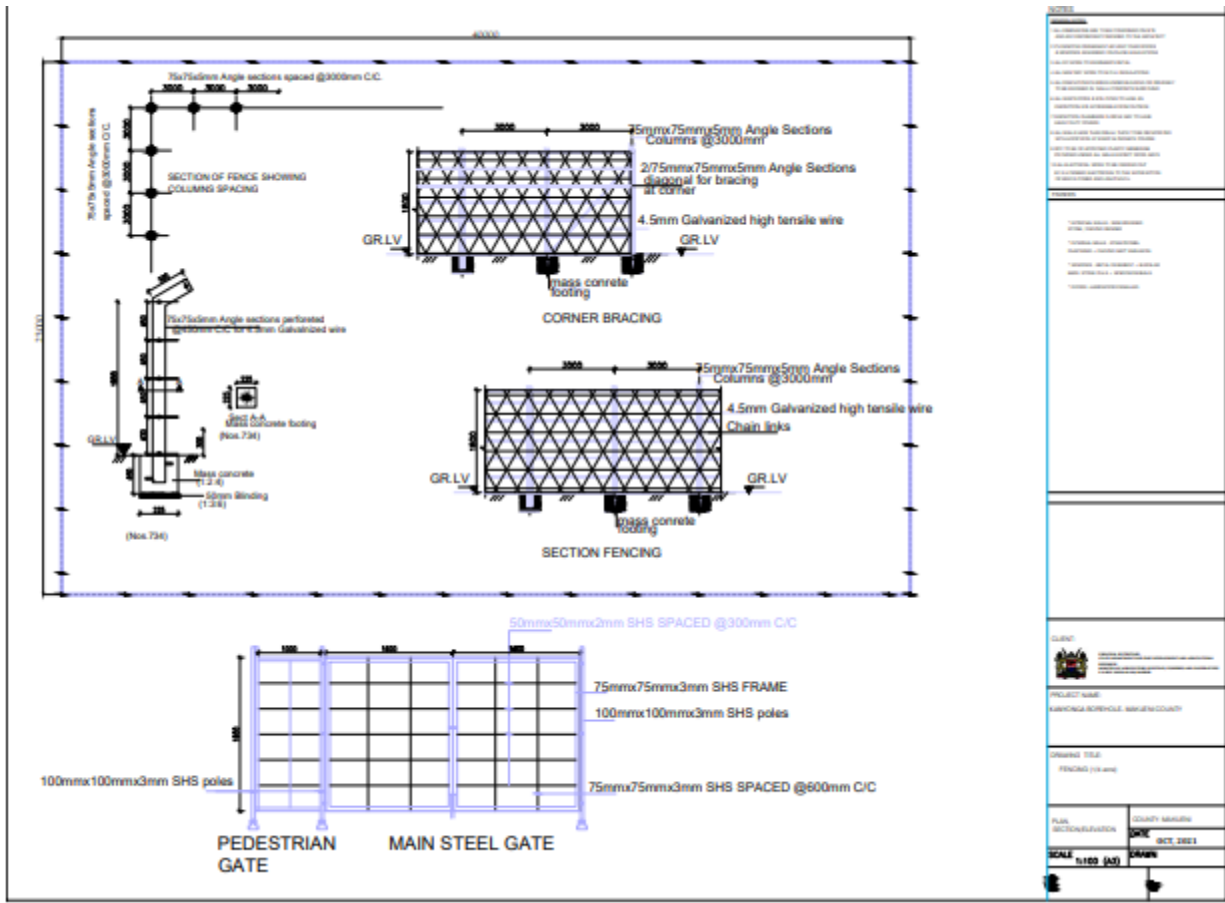

Supplementary Information

PART 3 – Conditions of Contract and Contract Forms

Section VII. General Conditions (GC)

These **General Conditions (GC)**, read in conjunction with the **Particular Conditions (PC)** and other documents listed therein, should be a complete document expressing fairly the rights and obligations of both parties.

Table of Clauses

1	General Provisions	185
1.1	Definitions.....	185
1.2	Interpretation.....	188
1.3	Communications	188
1.4	Law and Language.....	189
1.5	Priority of Documents.....	190
1.6	Contract Agreement.....	190
1.7	Assignment.....	190
1.8	Care and Supply of Documents	190
1.9	Confidential Details	191
1.10	Compliance with Laws.....	191
1.11	Joint and Several Liability	192
1.12	Inspections and Audit by the Bank.....	192
1.13	Project Manager’s Decisions	192
1.14	Delegation	192
1.15	Subcontracting	193
1.16	Personnel and Equipment.....	193
1.17	Other Contractors.....	193
1.18	Employer’s and Contractor’s Risks	193
1.19	Employer’s Risks	194
1.20	Contractor’s Risks.....	194
1.21	Insurance	194
1.22	Site Investigation Reports.....	195
1.23	Contractors to Construct the Works.....	195
1.24	The Works to Be Completed by the Intended Completion Date	195
1.25	Approval by the Project Manager	195
1.26	Safety	196
1.27	Discoveries.....	196
1.28	Possession of the Site.....	196
1.29	Access to the Site.....	196
1.30	Instructions.....	196
1.31	Appointment of the Adjudicator	196
1.32	Procedure for Disputes.....	196
2	Time Control	197
2.1	Programme	197
2.2	Extension of the Intended Completion Date.....	197
2.3	Acceleration	198
2.4	Delays Ordered by the Project Manager	198
2.5	Management Meetings	198
2.6	Early Warning	199

3 Quality Control	199
3.1 Identifying Defects.....	199
3.2 Tests	199
3.3 Correction of Defects.....	199
3.4 Uncorrected Defects.....	199
4 Cost Control.....	199
4.1 Contract Price.....	199
4.2 Changes in the Contract Price.....	200
4.3 Variations	200
4.4 Cash Flow Forecasts	201
4.5 Payment Certificates	201
4.6 Payments	202
4.7 Compensation Events.....	202
4.8 Tax	203
4.9 Currencies	204
4.10 Price Adjustment.....	204
4.11 Retention.....	204
4.12 Liquidated Damages	205
4.13 Bonus	205
4.14 Advance Payment	205
4.15 Securities	205
4.16 Dayworks	206
4.17 Cost of Repairs.....	206
5 Staff and Labour	207
5.1 Forced Labour.....	207
5.2 Child Labour	207
5.3 Workers' Organizations	207
5.4 Non-Discrimination and Equal Opportunity.....	208
6 Force Majeure	209
6.1 Definition of Force Majeure	209
6.2 Notice of Force Majeure	209
6.3 Duty to Minimise Delay	210
6.4 Consequences of Force Majeure	210
6.5 Force Majeure Affecting Subcontractor	210
6.6 Optional Termination, Payment and Release.....	210
6.7 Release from Performance	211
7 Finishing the Contract.....	212
7.1 Completion.....	212
7.2 Taking Over	212

7.3	Final Account	212
7.4	Operating and Maintenance Manuals	212
7.5	Termination	212
7.6	Fraud and Corruption	213
7.7	Payment upon Termination	215
7.8	Property	215
7.9	Release from Performance	216
7.10	Suspension of Bank Financing	216
7.11	Eligibility	216

Section VII. General Conditions

[Name of Employer] _____

[Name of Contract] _____

1. General Provisions

1.1 Definitions

In the Conditions of Contract (“these Conditions”), which include **Particular Conditions**, and these **General Conditions**, the following words and expressions shall have the meanings stated. Words indicating persons or parties include corporations and other legal entities, except where the context requires otherwise.

1.1.1 The Contract

1.1.1.1 “Contract” means the Contract Agreement, the Letter of Acceptance, the Letter of Bid, these Conditions, the Specification, the Schedules, and the further documents (if any) which are listed in the Contract Agreement or in the Letter of Acceptance.

1.1.1.2 “Contract Agreement” means the contract agreement referred to in **GC** Clause 1.6 [Contract Agreement].

1.1.1.3 “Letter of Acceptance” means the letter of formal acceptance, signed by the Employer, of the Letter of Bid, including any annexed memoranda comprising agreements between and signed by both Parties. If there is no such letter of acceptance, the expression “Letter of Acceptance” means the Contract Agreement and the date of issuing or receiving the Letter of Acceptance means the date of signing the Contract Agreement.

1.1.1.4 “Letter of Bid” means the document entitled letter of bid, which was completed by the Contractor and includes the signed offer to the Employer for the Works.

1.1.1.5 “Specification” means the document entitled specification, as included in the Contract, and any additions and modifications to the specification in accordance with the Contract. Such document specifies the Works.

1.1.1.6 “Drawings” means the drawings of the Works, as included in the Contract, and any additional and modified drawings issued by (or on behalf of) the Employer in accordance with the Contract.

1.1.1.7 “Schedules” means the document(s) entitled schedules, completed by the Contractor and submitted with the Letter of Bid, as included in the Contract. Such document may include the Bill of Quantities, data, lists, and schedules of rates and/or prices.

- 1.1.1.8 The Activity Schedule is a schedule of the activities comprising the construction, installation, testing, and commissioning of the Works in a lump sum contract. It includes a lump sum price for each activity, which is used for valuations and for assessing the effects of Variations and Compensation Events.
- 1.1.1.10 “Bid” means the Letter of Bid and all other documents which the Contractor submitted with the Letter of Bid, as included in the Contract.
- 1.1.1.11 **PC** means **Particular Conditions**
- 1.1.2 Parties and Persons**
- 1.1.2.1 “Party” means the Employer or the Contractor, as the context requires.
- 1.1.2.2 “Employer” means the person named as employer in the **Particular Conditions** and the legal successors in title to this person.
- 1.1.2.3 “Contractor” means the person(s) named as contractor in the Letter of Bid accepted by the Employer and the legal successors in title to this person(s).
- 1.1.2.4 “Project Manager” is the person named in the **PC** (or any other competent person appointed by the Employer and notified to the Contractor, to act in replacement of the Project Manager) who is responsible for supervising the execution of the Works and administering the Contract.
- 1.1.2.5 “Subcontractor” means any person named in the Contract as a subcontractor, or any person appointed as a subcontractor, for a part of the Works; and the legal successors in title to each of these persons.
- 1.1.2.6 “Bank” means the financing institution (if any) named in the **PC**.
- 1.1.2.7 “Borrower” means the person (if any) named as the borrower in the **PC**.
- 1.1.2.8 The “Adjudicator” is the person appointed jointly by the Employer and the Contractor to resolve disputes in the first instance, as provided for in **GC** Clause 1.32.
- 1.1.3 Dates, Tests, Periods and Completion**
- 1.1.3.1 “Base Date” means the date 28 days prior to the latest date for submission of the Bid.
- 1.1.3.2 “Commencement Date” means the date notified under the **PC**.
- 1.1.3.3 “Completion Date” means the date for completion of the Works, or a Section (as the case may be) as certified by the Project Manager, in accordance with **GC** Clause 7.1.1, and as stipulated in the **PC**.
- 1.1.3.4 “Test on Completion” means the tests (if any) which are specified in the Contract and which are carried out in accordance with the Specification for the purpose of issuing the “Certificate of Completion of the Works”.
- 1.1.3.5 “Taking-Over Certificate” or “Certificate of Completion of the Works” means a certificate issued under **GC** Clause 7.1 [Completion].
- 1.1.3.6 “day” means a calendar day and “year” means 365 days.

1.1.3.7 “Dayworks” are varied work inputs subject to payment on a time basis for the Contractor’s employees and Equipment, in addition to payments for associated Materials and Plant.

1.1.4 Money and Payments

1.1.4.1 “Initial Contract Amount” means the amount accepted in the Letter of Acceptance for the execution and completion of the Works and the remedying of any defects.

1.1.4.2 “Contract Price” means the price defined in **GC** Clause 4.1 [Contract Price], and includes adjustments in accordance with the Contract.

1.1.4.3 “Compensation Events” are those defined in **GC** Clause 4.7 [Compensation Events] hereunder.

1.1.5 Works and Goods

1.1.5.1 “Contractor’s Equipment” means all apparatus, machinery, vehicles and other things required for the execution and completion of the Works and the remedying of any defects. However, Contractor’s Equipment excludes Temporary Works, Employer’s Equipment (if any), Plant, Materials and any other things intended to form or forming part of the Permanent Works.

1.1.5.2 “Goods” means Contractor’s Equipment, Materials, Plant and Temporary Works, or any of them as appropriate.

1.1.5.3 “Materials” means things of all kinds (other than Plant) intended to form or forming part of the Permanent Works, including the supply-only materials (if any) to be supplied by the Contractor under the Contract.

1.1.5.4 “Permanent Works” means the permanent works to be executed by the Contractor under the Contract.

1.1.5.5 “Plant” means the apparatus, machinery and other equipment intended to form or forming part of the Permanent Works, including vehicles purchased for the Employer and relating to the construction or operation of the Works.

1.1.5.6 “Section” means a part of the Works specified in the **PC** as a Section (if any).

1.1.5.7 “Temporary Works” means all temporary works of every kind (other than Contractor’s Equipment) required on Site for the execution and completion of the Permanent Works and the remedying of any defects.

1.1.5.8 “Works” mean the Permanent Works and the Temporary Works, or either of them as appropriate, and as described in the **PC**.

1.1.6 Other Definitions

1.1.6.1 “Contractor’s Documents” means the calculations, computer programs and other software, drawings, manuals, models and other documents of a technical nature (if any) supplied by the Contractor under the Contract.

1.1.6.2 “Country” means the country in which the Site (or most of it) is located.

1.1.6.3 “Force Majeure” is defined in **GC** Clause 6.1 [Force Majeure].

- 1.1.6.4 “Laws” means all national (or state) legislation, statutes, ordinances and other laws, and regulations and by-laws of any legally constituted public authority.
- 1.1.6.5 “Performance Security” means the security (or securities, if any) under GC Clause 4.15 [Securities].
- 1.1.6.6 “Site” means the places where the Permanent Works are to be executed including storage and working areas and to which Plant and Materials are to be delivered, and any other places as may be specified in the PC as forming part of the Site.
- 1.1.6.8 “Unforeseeable” or “Unforeseen” means not reasonably foreseeable by an experienced Contractor by the Base Date.
- 1.1.6.9 “Variation” means any change to the Works, which is instructed or approved as a variation under GC Clause 4.3 [Variations].

1.2 Interpretation

- 1.2.1 Interpretation In the Contract, except where the context requires otherwise:
- (a) words indicating one gender include all genders;
 - (b) words indicating the singular also include the plural and words indicating the plural also include the singular;
 - (c) provisions including the word “agree”, “agreed” or “agreement” require the agreement to be recorded in writing;
 - (d) “written” or “in writing” means hand-written, type-written, printed or electronically made, and resulting in a permanent record;
 - (e) the word “tender” is synonymous with “bid” and “tenderer” with “bidder” and the words “tender documents” with “bidding documents”.
- 1.2.2 The marginal words and other headings shall not be taken into consideration in the interpretation of these Conditions.
- 1.2.3 If sectional completion is specified in the PC, references in the GC to the Works, the Completion Date, and the Intended Completion Date apply to any Section of the Works (other than references to the Completion Date and Intended Completion Date for the whole of the Works).

1.3 Communications

- 1.3.1 Wherever these Conditions provide for the giving or issuing of approvals, certificates, consents, determinations, notices, requests and discharges, these communications shall be:
- (a) in writing and delivered by hand (against receipt), sent by mail or courier, or transmitted using any of the agreed systems of electronic transmission as stated in the PC; and
 - (b) delivered, sent or transmitted to the address for the recipient’s communications as stated in the PC. However:

- (i) if the recipient gives notice of another address, communications shall thereafter be delivered accordingly; and
- (ii) if the recipient has not stated otherwise when requesting an approval or consent, it may be sent to the address from which the request was issued

1.3.2 Approvals, certificates, consents and determinations shall not be unreasonably withheld or delayed. When a certificate is issued to a Party, the certifier shall send a copy to the other Party.

1.3.3 When a notice is issued to a Party, by the other Party or the Project Manager, a copy shall be sent to the Project Manager or the other Party, as the case may be.

1.4 Law and Language

1.4.1 The Contract shall be governed by the law of the country or other jurisdiction stated in the **PC**.

The ruling language of the Contract shall be that stated in the **PC**.

The language for communications shall be that stated in the **PC**. If no language is stated there, the language for communications shall be the ruling language of the Contract.

1.4.2 Supporting documents and printed literature that are part of the Contract may be in another language provided they are accompanied by an accurate translation of the relevant passages in the language specified, in which case, for purposes of interpretation of the Contract, this translation shall govern.

The Contractor shall bear all costs of translation to the governing language and all risks of the accuracy of such translation, for documents provided by the Contractor.

1.5 Priority of Documents

1.5.1 The documents forming the Contract are to be taken as mutually explanatory of one another. For the purposes of interpretation, the priority of the documents shall be in accordance with the following sequence:

- (a) the Contract Agreement (if any),
- (b) the Letter of Acceptance,
- (c) the Bid,
- (d) the Particular Conditions
- (e) these General Conditions,
- (f) the Specification,
- (g) the Drawings, and
- (h) the Schedules and any other documents forming part of the Contract.

1.5.2 If an ambiguity or discrepancy is found in the documents, the Project Manager shall issue any necessary clarification or instruction.

1.6 Contract Agreement

1.6.1 The Parties shall enter into a Contract Agreement within 28 days after the Contractor receives the Letter of Acceptance, unless the **Particular Conditions** establish otherwise. The Contract Agreement shall be based upon the relevant form provided in Section IX, Contract Forms. The costs of stamp duties and similar charges (if any) imposed by law in connection with entry into the Contract Agreement shall be borne by the Employer.

1.7 Assignment

1.7.1 Neither Party shall assign the whole or any part of the Contract or any benefit or interest in or under the Contract. However, either Party:

- (a) may assign the whole or any part with the prior agreement of the other Party, at the sole discretion of such other Party, and
- (b) may, as security in favour of a bank or financial institution, assign its right to any moneys due, or to become due, under the Contract.

1.8 Care and Supply of Documents

1.8.1 The Specification and Drawings shall be in the custody and care of the Employer. Unless otherwise stated in the Contract, two copies of the Contract and of each subsequent Drawing shall be supplied to the Contractor, who may make or request further copies at the cost of the Contractor.

- 1.8.2 Each of the Contractor's Documents shall be in the custody and care of the Contractor, unless and until taken over by the Employer. Unless otherwise stated in the Contract, the Contractor shall supply to the Project Manager six copies of each of the Contractor's Documents.
- 1.8.3 The Contractor shall keep, on the Site, a copy of the Contract, publications named in the Specification, the Contractor's Documents (if any), the Drawings and Variations and other communications given under the Contract. The Employer's Personnel shall have the right of access to all these documents at all reasonable times.
- 1.8.4 If a Party becomes aware of an error or defect in a document which was prepared for use in executing the Works, the Party shall promptly give notice to the other Party of such error or defect.

1.9 Confidential Details

- 1.9.1 The Contractor's and the Employer's Personnel shall disclose all such confidential and other information as may be reasonably required in order to verify the Contractor's compliance with the Contract and allow its proper implementation.

Each of them shall treat the details of the Contract as private and confidential, except to the extent necessary to carry out their respective obligations under the Contract or to comply with applicable Laws. Each of them shall not publish or disclose any particulars of the Works prepared by the other Party without the previous agreement of the other Party. However, the Contractor shall be permitted to disclose any publicly available information, or information otherwise required to establish his qualifications to compete for other projects.

- 1.9.2 Notwithstanding the above, the Contractor may furnish to its Subcontractor(s) such documents, data and other information it receives from the Employer to the extent required for the Subcontractor(s) to perform its work under the Contract, in which event the Contractor shall obtain from such Subcontractor(s) an undertaking of confidentiality similar to that imposed on the Contractor under this Clause.

1.10 Compliance with Laws

- 1.10.1 The Contractor shall, in performing the Contract, comply with applicable Laws.
- 1.10.2 Unless otherwise stated in the **Particular Conditions**:
- (a) the Employer shall acquire and pay for all permits, approvals and/or licenses from all local, state or national government authorities or public service undertakings in the Employer's Country, which (i) such authorities or undertakings require the Employer to obtain in the Employer's name, and (ii) are necessary for the execution of the Contract, including those required for the performance by both the Contractor and the Employer of their respective obligations under the Contract;

- (b) the Contractor shall acquire and pay for all permits, approvals and/or licenses from all local, state or national government authorities or public service undertakings in the Employer's Country, which such authorities or undertakings require the Contractor to obtain in its name and which are necessary for the performance of the Contract, including, without limitation, visas for the Contractor's and Subcontractor's personnel and entry permits for all imported Contractor's Equipment. The Contractor shall acquire all other permits, approvals and/or licenses that are not the responsibility of the Employer under GC Clause 1.10.2(a) hereof and that are necessary for the performance of the Contract. The Contractor shall indemnify and hold harmless the Employer from and against any and all liabilities, damages, claims, fines, penalties and expenses of whatever nature arising or resulting from the violation of such laws by the Employer or its personnel, including the Subcontractors and their personnel, but without prejudice to GC Clause 1.10.1 hereof.

1.11 Joint and Several Liability

- 1.11.1 If the Contractor is a joint venture, consortium, or association (JVCA) of two or more persons, all such persons shall be jointly and severally bound to the Employer for the fulfilment of the provisions of the Contract, unless otherwise specified in the PC, and shall designate one of such persons to act as a leader with authority to bind the JVCA. The composition or the constitution of the JVCA shall not be altered without the prior consent of the Employer.

1.12 Inspections and Audit by the Bank

- 1.12.1 The Contractor shall permit the Bank and/or persons appointed by the Bank to inspect the Site and/or the Contractor's accounts and records relating to the performance of the Contract and to have such accounts and records audited by auditors appointed by the Bank if required by the Bank.
- 1.12.2 The Contractor shall maintain all documents and records related to the Contract for a period of three (3) years after completion of the Works. The Contractor shall provide any documents necessary for the investigation of allegations of fraud, collusion, coercion, obstruction or corruption and require its employees or agents with knowledge of the Contract to respond to questions from the Bank.

1.13 Project Manager's Decisions

- 1.13.1 Except where otherwise specifically stated, the Project Manager shall decide contractual matters between the Employer and the Contractor in the role representing the Employer.

1.14 Delegation

- 1.14.1 The Project Manager may delegate any of his duties and responsibilities and may cancel any delegation after notifying the Contractor.

1.15 Subcontracting

- 1.15.1 The Contractor may subcontract with the approval of the Project Manager, but may not assign the Contract without the approval of the Employer in writing. Subcontracting shall not alter the Contractor's obligations.

1.16 Personnel and Equipment

- 1.16.1 The Contractor shall employ the key personnel and use the equipment identified in its Bid, to carry out the Works or other personnel and equipment approved by the Project Manager. The Project Manager shall approve any proposed replacement of key personnel and equipment only if their relevant qualifications or characteristics are substantially equal to or better than those proposed in the Bid.

- 1.16.2 If the Project Manager asks the Contractor to remove a person who is a member of the Contractor's staff or work force, stating the reasons, the Contractor shall ensure that the person leaves the Site within seven days and has no further connection with the work in the Contract.

1.17 Other Contractors

- 1.17.1 The Contractor shall cooperate and share the Site with other contractors, public authorities, utilities, and the Employer between the dates given in the Schedule of Other Contractors, as referred to in the **PC**. The Contractor shall also provide facilities and services for them as described in the Schedule. The Employer may modify the Schedule of Other Contractors, and shall notify the Contractor of any such modification.

1.18 Employer's and Contractor's Risks

- 1.18.1 The Employer carries the risks which this Contract states are Employer's risks, and the Contractor carries the risks which this Contract states are Contractor's risks.

1.19 Employer's Risks

1.19.1 From the Start Date until the Defects Liability Certificate has been issued, the following are Employer's risks:

- (a) The risk of personal injury, death, or loss of or damage to property (excluding the Works, Plant, Materials, and Equipment), which are due to
 - (i) use or occupation of the Site by the Works or for the purpose of the Works, which is the unavoidable result of the Works or
 - (ii) negligence, breach of statutory duty, or interference with any legal right by the Employer or by any person employed by or contracted to him except the Contractor.
- (b) The risk of damage to the Works, Plant, Materials, and Equipment to the extent that it is due to a fault of the Employer or in the Employer's design, or due to war or radioactive contamination directly affecting the country where the Works are to be executed.

1.19.2 From the Completion Date until the Defects Liability Certificate has been issued, the risk of loss of or damage to the Works, Plant, and Materials is an Employer's risk except loss or damage due to

- (a) a Defect which existed on the Completion Date,
- (b) an event occurring before the Completion Date, which was not itself an Employer's risk, or
- (c) the activities of the Contractor on the Site after the Completion Date.

1.20 Contractor's Risks

1.20.1 From the Starting Date until the Defects Liability Certificate has been issued, the risks of personal injury, death, and loss of or damage to property (including, without limitation, the Works, Plant, Materials, and Equipment) which are not Employer's risks are Contractor's risks.

1.21 Insurance

1.21.1 The Contractor shall provide, in the joint names of the Employer and the Contractor, insurance cover from the Start Date to the end of the Defects Liability Period, in the amounts and deductibles stated in the **PC** for the following events which are due to the Contractor's risks:

- (a) loss of or damage to the Works, Plant, and Materials;
- (b) loss of or damage to Equipment;
- (c) loss of or damage to property (except the Works, Plant, Materials, and Equipment) in connection with the Contract; and
- (d) personal injury or death.

- 1.21.2 Policies and certificates for insurance shall be delivered by the Contractor to the Project Manager for the Project Manager's approval before the Commencement Date. All such insurance shall provide for compensation to be payable in the types and proportions of currencies required to rectify the loss or damage incurred.
- 1.21.3 If the Contractor does not provide any of the policies and certificates required, the Employer may effect the insurance which the Contractor should have provided and recover the premiums the Employer has paid from payments otherwise due to the Contractor or, if no payment is due, the payment of the premiums shall be a debt due.
- 1.21.4 Alterations to the terms of insurance shall not be made without the approval of the Project Manager.
- 1.21.5 Both parties shall comply with any conditions of the insurance policies.
- 1.22 Site Investigation Reports**
- 1.22.1 The Contractor, in preparing the Bid, shall rely on any Site Investigation Reports referred to in the PC, supplemented by any information available to the Bidder.
- 1.23 Contractors to Construct the Works**
- 1.23.1 The Contractor shall construct and install the Works in accordance with the Specifications and Drawings.
- 1.24 The Works to Be Completed by the Intended Completion Date**
- 1.24.1 The Contractor may commence execution of the Works on the Start Date and shall carry out the Works in accordance with the Program submitted by the Contractor, as updated with the approval of the Project Manager, and complete them by the Intended Completion Date.
- 1.25 Approval by the Project Manager**
- 1.25.1 The Contractor shall submit Specifications and Drawings showing the proposed Temporary Works to the Project Manager, who is to approve them if they comply with the Specifications and Drawings.
- 1.25.2 The Contractor shall be responsible for design of Temporary Works.
- 1.25.3 The Project Manager's approval shall not alter the Contractor's responsibility for design of the Temporary Works.
- 1.25.4 The Contractor shall obtain approval of third parties to the design of the Temporary Works, where required.
- 1.25.5 All Drawings prepared by the Contractor for the execution of the temporary or permanent Works, are subject to prior approval by the Project Manager before this use.

1.26 Safety

1.26.1 The Contractor shall be responsible for the safety of all activities on the Site.

1.27 Discoveries

1.27.1 Anything of historical or other interest or of significant value unexpectedly discovered on the Site shall be the property of the Employer. The Contractor shall notify the Project Manager of such discoveries and carry out the Project Manager's instructions for dealing with them.

1.28 Possession of the Site

1.28.1 The Employer shall give possession of all parts of the Site to the Contractor. If possession of a part is not given by the date stated in the **PC**, the Employer shall be deemed to have delayed the start of the relevant activities, and this shall be a Compensation Event.

1.29 Access to the Site

1.29.1 The Contractor shall allow the Project Manager and any person authorized by the Project Manager access to the Site and to any place where work in connection with the Contract is being carried out or is intended to be carried out.

1.30 Instructions

1.30.1 The Contractor shall carry out all instructions of the Project Manager which comply with the applicable laws where the Site is located.

1.31 Appointment of the Adjudicator

1.31.1 The Adjudicator shall be appointed jointly by the Employer and the Contractor, at the time of the Employer's issuance of the Letter of Acceptance. If, in the Letter of Acceptance, the Employer does not agree on the appointment of the Adjudicator, the Employer will request the Appointing Authority designated in the **PC**, to appoint the Adjudicator within 14 days of receipt of such request.

1.31.2 Should the Adjudicator resign or die, or should the Employer and the Contractor agree that the Adjudicator is not functioning in accordance with the provisions of the Contract, a new Adjudicator shall be jointly appointed by the Employer and the Contractor. In case of disagreement between the Employer and the Contractor, within 30 days, the Adjudicator shall be designated by the Appointing Authority designated in the **PC** at the request of either party, within 14 days of receipt of such request.

1.32 Procedure for Disputes

- 1.32.1 If the Contractor believes that a decision taken by the Project Manager was either outside the authority given to the Project Manager by the Contract or that the decision was wrongly taken, the decision shall be referred to the Adjudicator within 14 days of the notification of the Project Manager's decision.
- 1.32.2 The Adjudicator shall give a decision in writing within 28 days of receipt of a notification of a dispute.
- 1.32.3 The Adjudicator shall be paid by the hour at the rate specified in the **PC**, together with reimbursable expenses of the types specified in the **PC**, and the cost shall be divided equally between the Employer and the Contractor, whatever decision is reached by the Adjudicator. Either party may refer a decision of the Adjudicator to an Arbitrator within 28 days of the Adjudicator's written decision. If neither party refers the dispute to arbitration within the above 28 days, the Adjudicator's decision shall be final and binding.
- 1.32.4 The arbitration shall be conducted in accordance with the arbitration procedures published by the institution named and in the place specified in the **PC**.

2. Time Control

2.1 Programme

- 2.1.1 Within the time stated in the **PC**, after the date of the Letter of Acceptance, the Contractor shall submit to the Project Manager for approval a Programme showing the general methods, arrangements, order, and timing for all the activities in the Works. In the case of a lump sum contract, the activities in the Programme shall be consistent with those in the Activity Schedule.
- 2.1.2 An update of the Programme shall be a program showing the actual progress achieved on each activity and the effect of the progress achieved on the timing of the remaining work, including any changes to the sequence of the activities.
- 2.1.3 The Contractor shall submit to the Project Manager for approval an updated Programme at intervals no longer than the period stated in the **PC**. If the Contractor does not submit an updated Programme within this period, the Project Manager may withhold the amount stated in the **PC** from the next payment certificate and continue to withhold this amount until the next payment after the date on which the overdue Programme has been submitted. In the case of a lump sum contract, the Contractor shall provide an updated Activity Schedule within 14 days of being instructed to by the Project Manager.
- 2.1.4 The Project Manager's approval of the Programme shall not alter the Contractor's obligations. The Contractor may revise the Programme and submit it to the Project Manager again at any time. A revised Programme shall show the effect of Variations and Compensation Events.

2.2 Extension of the Intended Completion Date

2.2.1 The Project Manager shall extend the Intended Completion Date if a Compensation Event occurs or a Variation is issued which makes it impossible for Completion to be achieved by the Intended Completion Date without the Contractor taking steps to accelerate the remaining work, which would cause the Contractor to incur additional cost.

2.2.2 The Project Manager shall decide whether and by how much to extend the Intended Completion Date within 21 days of the Contractor asking the Project Manager for a decision upon the effect of a Compensation Event or Variation and submitting full supporting information. If the Contractor has failed to give early warning of a delay or has failed to cooperate in dealing with a delay, the delay by this failure shall not be considered in assessing the new Intended Completion Date.

2.3 Acceleration

2.3.1 When the Employer wants the Contractor to finish before the Intended Completion Date, the Project Manager shall obtain priced proposals for achieving the necessary acceleration from the Contractor. If the Employer accepts these proposals, the Intended Completion Date shall be adjusted accordingly and confirmed by both the Employer and the Contractor.

2.3.2 If the Contractor's priced proposals for acceleration are accepted by the Employer, they are incorporated in the Contract Price and treated as a Variation.

2.4 Delays Ordered by the Project Manager

2.4.1 The Project Manager may instruct the Contractor to delay the start or progress of any activity within the Works.

2.5 Management Meetings

2.5.1 Either the Project Manager or the Contractor may require the other to attend a management meeting. The business of a management meeting shall be to review the plans for remaining work and to deal with matters raised in accordance with the early warning procedure.

2.5.2 The Project Manager shall record the business of management meetings and provide copies of the record to those attending the meeting and to the Employer. The responsibility of the parties for actions to be taken shall be decided by the Project Manager either at the management meeting or after the management meeting and stated in writing to all who attended the meeting.

2.6 Early Warning

- 2.6.1 The Contractor shall warn the Project Manager at the earliest opportunity of specific likely future events or circumstances that may adversely affect the quality of the work, increase the Contract Price, or delay the execution of the Works. The Project Manager may require the Contractor to provide an estimate of the expected effect of the future event or circumstance on the Contract Price and Completion Date. The estimate shall be provided by the Contractor as soon as reasonably possible.
- 2.6.2 The Contractor shall cooperate with the Project Manager in making and considering proposals for how the effect of such an event or circumstance can be avoided or reduced by anyone involved in the work and in carrying out any resulting instruction of the Project Manager.

3. Quality Control**3.1 Identifying Defects**

- 3.1.1 The Project Manager shall check the Contractor's work and notify the Contractor of any Defects that are found. Such checking shall not affect the Contractor's responsibilities. The Project Manager may instruct the Contractor to search for a Defect and to uncover and test any work that the Project Manager considers may have a Defect.

3.2 Tests

- 3.2.1 If the Project Manager instructs the Contractor to carry out a test not specified in the Specification to check whether any work has a Defect and the test shows that it does, the Contractor shall pay for the test and any samples. If there is no Defect, the test shall be a Compensation Event.

3.3 Correction of Defects

- 3.3.1 The Project Manager shall give notice to the Contractor of any Defects before the end of the Defects Liability Period, which begins at Completion, and is defined in the PC. The Defects Liability Period shall be extended for as long as Defects remain to be corrected.

Every time notice of a Defect is given, the Contractor shall correct the notified Defect within the length of time specified by the Project Manager's notice.

3.4 Uncorrected Defects

- 3.4.1 If the Contractor has not corrected a Defect within the time specified in the Project Manager's notice, the Project Manager shall assess the cost of having the Defect corrected, and the Contractor shall pay this amount.

4. Cost Control**4.1 Contract Price**

4.1.1 In the case of an admeasurement contract, the Bill of Quantities shall contain priced items for the Works to be performed by the Contractor. The Bill of Quantities is used to calculate the Contract Price. The Contractor will be paid for the quantity of the work accomplished at the rate in the Bill of Quantities for each item.

4.1.2 In the case of a lump sum contract, the Activity Schedule shall contain the priced activities for the Works to be performed by the Contractor. The Activity Schedule is used to monitor and control the performance of activities on which basis the Contractor will be paid. If payment for Materials on Site shall be made separately, the Contractor shall show delivery of Materials to the Site separately on the Activity Schedule.

4.2 Changes in the Contract Price

4.2.1 In the case of an admeasurement contract:

- (a) If the final quantity of the work done differs from the quantity in the Bill of Quantities for the particular item by more than 25 percent, provided the change exceeds 1 percent of the Initial Contract Price, the Project Manager shall adjust the rate to allow for the change.
- (b) The Project Manager shall not adjust rates from changes in quantities if thereby the Initial Contract Price is exceeded by more than 15 percent, except with the prior approval of the Employer.
- (c) If requested by the Project Manager, the Contractor shall provide the Project Manager with a detailed cost breakdown of any rate in the Bill of Quantities.

4.2.2 In the case of a lump sum contract, the Activity Schedule shall be amended by the Contractor to accommodate changes of Programme or method of working made at the Contractor's own discretion. Prices in the Activity Schedule shall not be altered when the Contractor makes such changes to the Activity Schedule.

4.3 Variations

4.3.1 All Variations shall be included in updated Programs, and, in the case of a lump sum contract, also in the Activity Schedule, produced by the Contractor.

4.3.2 The Contractor shall provide the Project Manager with a quotation for carrying out the Variation when requested to do so by the Project Manager. The Project Manager shall assess the quotation, which shall be given within seven (7) days of the request or within any longer period stated by the Project Manager and before the Variation is ordered.

- 4.3.3 If the Contractor's quotation is unreasonable, the Project Manager may order the Variation and make a change to the Contract Price, which shall be based on the Project Manager's own forecast of the effects of the Variation on the Contractor's costs.
- 4.3.4 If the Project Manager decides that the urgency of varying the work would prevent a quotation being given and considered without delaying the work, no quotation shall be given and the Variation shall be treated as a Compensation Event.
- 4.3.5 The Contractor shall not be entitled to additional payment for costs that could have been avoided by giving early warning.
- 4.3.6 In the case of an admeasurement contract, if the work in the Variation corresponds to an item description in the Bill of Quantities and if, in the opinion of the Project Manager, the quantity of work above the limit stated in GC Clause 4.2.1 or the timing of its execution do not cause the cost per unit of quantity to change, the rate in the Bill of Quantities shall be used to calculate the value of the Variation. If the cost per unit of quantity changes, or if the nature or timing of the work in the Variation does not correspond with items in the Bill of Quantities, the quotation by the Contractor shall be in the form of new rates for the relevant items of work.
- 4.4 Cash Flow Forecasts**
- 4.4.1 When the Program, or, in the case of a lump sum contract, the Activity Schedule, is updated, the Contractor shall provide the Project Manager with an updated cash flow forecast. The cash flow forecast shall include different currencies, as defined in the Contract, converted as necessary using the Contract exchange rates.
- 4.5 Payment Certificates**
- 4.5.1 The Contractor shall submit to the Project Manager monthly statements of the estimated value of the work executed less the cumulative amount certified previously.
- 4.5.2 The Project Manager shall check the Contractor's monthly statement and certify the amount to be paid to the Contractor.
- 4.5.3 The value of work executed shall be determined by the Project Manager.
- 4.5.4 The value of work executed shall comprise:
- (a) In the case of an admeasurement contract, the value of the quantities of work in the Bill of Quantities that have been completed; or
 - (b) In the case of a lump sum contract, the value of work executed shall comprise the value of completed activities in the Activity Schedule.

4.5.5 The value of work executed shall include the valuation of Variations and Compensation Events.

4.5.6 The Project Manager may exclude any item certified in a previous certificate or reduce the proportion of any item previously certified in any certificate in the light of later information.

4.6 Payments

4.6.1 Payments shall be adjusted for deductions for advance payments and retention. The Employer shall pay the Contractor the amounts certified by the Project Manager within 28 days of the date of each certificate. If the Employer makes a late payment, the Contractor shall be paid interest on the late payment in the next payment. Interest shall be calculated from the date by which the payment should have been made up to the date when the late payment is made at the prevailing rate of interest for commercial borrowing for each of the currencies in which payments are made.

4.6.2 If an amount certified is increased in a later certificate or as a result of an award by the Adjudicator or an Arbitrator, the Contractor shall be paid interest upon the delayed payment as set out in this clause. Interest shall be calculated from the date upon which the increased amount would have been certified in the absence of dispute.

4.6.3 Unless otherwise stated, all payments and deductions shall be paid or charged in the proportions of currencies comprising the Contract Price.

4.6.4 Items of the Works for which no rate or price has been entered in shall not be paid for by the Employer and shall be deemed covered by other rates and prices in the Contract.

4.7 Compensation Events

4.7.1 The following shall be Compensation Events:

- (a) The Employer does not give access to a part of the Site by the Site Possession Date pursuant to GC Clause 1.29.
- (b) The Employer modifies the Schedule of Other Contractors in a way that affects the work of the Contractor under the Contract.
- (c) The Project Manager orders a delay or does not issue Drawings, Specifications, or instructions required for execution of the Works on time.
- (d) The Project Manager instructs the Contractor to uncover or to carry out additional tests upon work, which is then found to have no Defects.
- (e) The Project Manager unreasonably does not approve a subcontract to be let.
- (f) Ground conditions are substantially more adverse than could reasonably have been assumed before issuance of the Letter of Acceptance from the

information issued to bidders (including the Site Investigation Reports), from information available publicly and from a visual inspection of the Site.

- (g) The Project Manager gives an instruction for dealing with an unforeseen condition, caused by the Employer, or additional work required for safety or other reasons.
- (h) Other contractors, public authorities, utilities, or the Employer does not work within the dates and other constraints stated in the Contract, and they cause delay or extra cost to the Contractor.
- (i) The advance payment is delayed.
- (j) The effects on the Contractor of any of the Employer's Risks.
- (k) The Project Manager unreasonably delays issuing a Certificate of Completion.

4.7.2 If a Compensation Event would cause additional cost or would prevent the work being completed before the Intended Completion Date, the Contract Price shall be increased and/or the Intended Completion Date shall be extended. The Project Manager shall decide whether and by how much the Contract Price shall be increased and whether and by how much the Intended Completion Date shall be extended.

4.7.3 As soon as information demonstrating the effect of each Compensation Event upon the Contractor's forecast cost has been provided by the Contractor, it shall be assessed by the Project Manager, and the Contract Price shall be adjusted accordingly. If the Contractor's forecast is deemed unreasonable, the Project Manager shall adjust the Contract Price based on the Project Manager's own forecast. The Project Manager shall assume that the Contractor shall react competently and promptly to the event.

4.7.4 The Contractor shall not be entitled to compensation to the extent that the Employer's interests are adversely affected by the Contractor's not having given early warning or not having cooperated with the Project Manager.

4.8 Tax

4.8.1 The Project Manager shall adjust the Contract Price if taxes, duties, and other levies are changed between the date 28 days before the submission of bids for the Contract and the date of the last Completion certificate. The adjustment shall be the change in the amount of tax payable by the Contractor, provided such changes are not already reflected in the Contract Price or are a result of GC Clause 4.10.

4.9 Currencies

- 4.9.1 Where payments are made in currencies other than the currency of the Employer's country specified in the **PC**, the exchange rates used for calculating the amounts to be paid shall be the exchange rates stated in the Contractor's Bid.

4.10 Price Adjustment

- 4.10.1 Prices shall be adjusted for fluctuations in the cost of inputs only if provided for in the **PC**. If so provided, the amounts certified in each payment certificate, before deducting for Advance Payment, shall be adjusted by applying the respective price adjustment factor to the payment amounts due in each currency. A separate formula of the type indicated below applies to each Contract currency:

$$P_c = A_c + B_c \text{Imc/Ioc}$$

where:

P_c is the adjustment factor for the portion of the Contract Price payable in a specific currency "c."

A_c and B_c are coefficients¹⁶ specified in the **PC**, representing the nonadjustable and adjustable portions, respectively, of the Contract Price payable in that specific currency "c;" and

Imc is the index prevailing at the end of the month being invoiced and Ioc is the index prevailing 28 days before Bid opening for inputs payable; both in the specific currency "c."

- 4.10.2 If the value of the index is changed after it has been used in a calculation, the calculation shall be corrected and an adjustment made in the next payment certificate. The index value shall be deemed to take account of all changes in cost due to fluctuations in costs.

4.11 Retention

- 4.11.1 The Employer shall retain from each payment due to the Contractor the proportion stated in the **PC** until Completion of the whole of the Works.
- 4.11.2 Upon the issue of a Certificate of Completion of the Works by the Project Manager, in accordance with **GC** Clause 7.1.1, half the total amount retained shall be repaid to the Contractor and half when the Defects Liability Period has passed and the Project Manager has certified that all Defects notified by the Project Manager to the Contractor before the end of this period have been corrected. The Contractor may substitute retention money with an "on demand" Bank guarantee.

¹⁶ The sum of the two coefficients A_c and B_c should be 1 (one) in the formula for each currency. Normally, both coefficients shall be the same in the formulae for all currencies, since coefficient A_c , for the nonadjustable portion of the payments, is a very approximate figure (usually 0.15) to take account of fixed cost elements or other nonadjustable components. The sum of the adjustments for each currency is added to the Contract Price.

4.12 Liquidated Damages

- 4.12.1 The Contractor shall pay liquidated damages to the Employer at the rate per day stated in the **PC** for each day that the Completion Date is later than the Intended Completion Date. The total amount of liquidated damages shall not exceed the amount defined in the **PC**. The Employer may deduct liquidated damages from payments due to the Contractor. Payment of liquidated damages shall not affect the Contractor's liabilities.
- 4.12.2 If the Intended Completion Date is extended after liquidated damages have been paid, the Project Manager shall correct any overpayment of liquidated damages by the Contractor by adjusting the next payment certificate. The Contractor shall be paid interest on the overpayment, calculated from the date of payment to the date of repayment, at the rates specified in **GC** Clause 4.6.1.

4.13 Bonus

- 4.13.1 The Contractor shall be paid a Bonus calculated at the rate per calendar day stated in the **PC** for each day (less any days for which the Contractor is paid for acceleration) that the Completion is earlier than the Intended Completion Date. The Project Manager shall certify that the Works are complete, although they may not be due to be complete.

4.14 Advance Payment

- 4.14.1 The Employer shall make advance payment to the Contractor of the amounts stated in the **PC** by the date stated in the **PC**, against provision by the Contractor of an Unconditional Bank Guarantee in a form and by a bank acceptable to the Employer in amounts and currencies equal to the advance payment. The Guarantee shall remain effective until the advance payment has been repaid, but the amount of the Guarantee shall be progressively reduced by the amounts repaid by the Contractor. Interest shall not be charged on the advance payment.
- 4.14.2 The Contractor is to use the advance payment only to pay for Equipment, Plant, Materials, and mobilization expenses required specifically for execution of the Contract. The Contractor shall demonstrate that advance payment has been used in this way by supplying copies of invoices or other documents to the Project Manager.
- 4.14.3 The advance payment shall be repaid by deducting proportionate amounts from payments otherwise due to the Contractor, following the schedule of completed percentages of the Works on a payment basis. No account shall be taken of the advance payment or its repayment in assessing valuations of work done, Variations, price adjustments, Compensation Events, Bonuses, or Liquidated Damages.

4.15 Securities

4.15.1 The Performance Security shall be provided to the Employer no later than the date specified in the Letter of Acceptance and shall be issued in an amount specified in the **PC**, by a bank or surety acceptable to the Employer, and denominated in the types and proportions of the currencies in which the Contract Price is payable. The Performance Security shall be valid until a date 28 days from the date of issue of the Certificate of Completion in the case of a Bank Guarantee, and until one year from the date of issue of the Completion Certificate in the case of a Performance Bond.

4.16 Dayworks

4.16.1 If applicable, the Dayworks rates in the Contractor's Bid shall be used for small additional amounts of work only when the Project Manager has given written instructions in advance for additional work to be paid for in that way.

4.16.2 All work to be paid for as Dayworks shall be recorded by the Contractor on forms approved by the Project Manager. Each completed form shall be verified and signed by the Project Manager within two days of the work being done.

4.16.3 The Contractor shall be paid for Dayworks subject to obtaining signed Dayworks forms.

4.17 Cost of Repairs

Loss or damage to the Works or Materials to be incorporated in the Works between the Start Date and the end of the Defects Correction periods shall be remedied by the Contractor at the Contractor's cost if the loss or damage arises from the Contractor's acts or omissions.

5. Staff and Labour

5.1 Forced Labour

5.1.1 The Contractor shall not employ forced labour, which consists of any work or service, not voluntarily performed, that is exacted from an individual under threat of force or penalty, and includes any kind of involuntary or compulsory labour, such as indentured labour, bonded labour or similar labour-contracting arrangements.

5.2 Child Labour

5.2.1 The Contractor shall not employ children in a manner that is economically exploitative, or is likely to be hazardous, or to interfere with the child's education, or to be harmful to the child's health or physical, mental, spiritual, moral, or social development. Where the relevant labour laws have provisions for employment of minors, the Contractor shall follow those laws applicable to the Contractor. Children below the age of 18 years shall not be employed in dangerous work.

5.3 Workers' Organizations

5.3.1 In countries where the relevant labour laws recognize workers' rights to form and to join workers' organisations of their choosing without interference and to bargain collectively, the Contractor shall comply with such laws. Where the relevant labour laws substantially restrict workers' organisations, the Contractor shall enable alternative means for Contractor's Personnel to express their grievances and protect their rights regarding working conditions and terms of employment. In either case described above, and where the relevant labour laws are silent, the Contractor shall not discourage Contractor's Personnel from forming or joining workers' organisations of their choosing or from bargaining collectively, and shall not discriminate or retaliate against the Contractor's Personnel who participate, or seek to participate, in such organisations and bargain collectively. The Contractor shall engage with such workers representatives. Worker organisations are expected to fairly represent the workers in the workforce.

5.4 Non-Discrimination and Equal Opportunity

- 5.4.1 The Contractor shall not make employment decisions on the basis of personal characteristics unrelated to inherent job requirements. The Contractor shall base the employment relationship on the principle of equal opportunity and fair treatment, and shall not discriminate with respect to aspects of the employment relationship, including recruitment and hiring, compensation (including wages and benefits), working conditions and terms of employment, access to training, promotion, termination of employment or retirement, and discipline. In countries where the relevant labour laws provide for non-discrimination in employment, the Contractor shall comply with such laws. When the relevant labour laws are silent on non-discrimination in employment, the Contractor shall meet this Clause's requirements. Special measures of protection or assistance to remedy past discrimination or selection for a particular job based on inherent requirements of the job shall not be deemed discrimination.

6. Force Majeure

6.1 Definition of Force Majeure

6.1.1 In this Clause, "Force Majeure" means an exceptional event or circumstance:

- (a) which is beyond a Party's control,
- (b) which such Party could not reasonably have provided against before entering into the Contract,
- (c) which, having arisen, such Party could not reasonably have avoided or overcome, and
- (d) which is not substantially attributable to the other Party.

Force Majeure may include, but is not limited to, exceptional events or circumstances of the kind listed below, so long as conditions (a) to (d) above are satisfied:

- (i) war, hostilities (whether war be declared or not), invasion, act of foreign enemies,
- (ii) rebellion, terrorism, sabotage by persons other than the Contractor's Personnel, revolution, insurrection, military or usurped power, or civil war,
- (iii) riot, commotion, disorder, strike or lockout by persons other than the Contractor's Personnel,
- (iv) munitions of war, explosive materials, ionising radiation or contamination by radio-activity, except as may be attributable to the Contractor's use of such munitions, explosives, radiation or radio-activity, and
- (v) natural catastrophes such as earthquake, hurricane, typhoon or volcanic activity.

6.2 Notice of Force Majeure

6.2.1 If a Party is or will be prevented from performing its substantial obligations under the Contract by Force Majeure, then it shall give notice to the other Party of the event or circumstances constituting the Force Majeure and shall specify the obligations, the performance of which is or will be prevented. The notice shall be given within 14 days after the Party became aware, or should have become aware, of the relevant event or circumstance constituting Force Majeure.

6.2.2 The Party shall, having given notice, be excused performance of its obligations for so long as such Force Majeure prevents it from performing them.

6.2.3 Notwithstanding any other provision of this Clause, Force Majeure shall not apply to obligations of either Party to make payments to the other Party under the Contract

6.3 Duty to Minimise Delay

6.3.1 Each Party shall at all times use all reasonable endeavours to minimise any delay in the performance of the Contract as a result of Force Majeure.

6.3.2 A Party shall give notice to the other Party when it ceases to be affected by the Force Majeure.

6.4 Consequences of Force Majeure

6.4.1 If the Contractor is prevented from performing its substantial obligations under the Contract by Force Majeure of which notice has been given under GC Clause 6.2 [Notice of Force Majeure], and suffers delay and/or incurs Cost by reason of such Force Majeure, the Contractor shall be entitled subject to GC Clause 1.32.1 [Procedure for Disputes] to:

- (a) an extension of time for any such delay, if completion is or will be delayed, under GC Clause 2.2 [Extension of the Intended Completion Date], and
- (b) if the event or circumstance is of the kind described in sub-paragraphs (i) to (iv) of GC Clause 6.1 [Definition of Force Majeure] and, in the case of GC Clause 6.1.1(d)(ii) to (iv), occurs in the Country, payment of any such Cost, including the costs of rectifying or replacing the Works and/or Goods damaged or destroyed by Force Majeure, to the extent they are not indemnified through the insurance policy referred to in GC Clause 1.21 [Insurance].

6.4.2 After receiving this notice, the Project Manager shall proceed in accordance with GC Clause 1.13 [Project Manager's Decisions] to agree or determine these matters.

6.5 Force Majeure Affecting Subcontractor

6.5.1 If any Subcontractor is entitled under any contract or agreement relating to the Works to relief from force majeure on terms additional to or broader than those specified in this Clause, such additional or broader force majeure events or circumstances shall not excuse the Contractor's non-performance or entitle him to relief under this Clause.

6.6 Optional Termination, Payment and Release

6.6.1 If the execution of substantially all the Works in progress is prevented for a continuous period of 84 days by reason of Force Majeure of which notice has been given under GC Clause 6.2 [Notice of Force Majeure], or for multiple periods which total more than 140 days due to the same notified Force Majeure, then either Party may give to the other Party a notice of termination of the

Contract. In this event, the termination shall take effect 7 days after the notice is given, and the Contractor shall proceed in accordance with GC Clause 7.5.5.

6.6.2 Upon such termination, the Project Manager shall determine the value of the work done and issue a Payment Certificate which shall include:

- (a) the amounts payable for any work carried out for which a price is stated in the Contract;
- (b) the Cost of Plant and Materials ordered for the Works which have been delivered to the Contractor, or of which the Contractor is liable to accept delivery: this Plant and Materials shall become the property of (and be at the risk of) the Employer when paid for by the Employer, and the Contractor shall place the same at the Employer's disposal;
- (c) other Costs or liabilities which in the circumstances were reasonably and necessarily incurred by the Contractor in the expectation of completing the Works;
- (d) the Cost of removal of Temporary Works and Contractor's Equipment from the Site and the return of these items to the Contractor's works in his country (or to any other destination at no greater cost); and
- (e) the Cost of repatriation of the Contractor's staff and labour employed wholly in connection with the Works at the date of termination.

6.7 Release from Performance

6.7.1 Notwithstanding any other provision of this Clause, if any event or circumstance outside the control of the Parties (including, but not limited to, Force Majeure) arises which makes it impossible or unlawful for either or both Parties to fulfill its or their contractual obligations or which, under the law governing the Contract, entitles the Parties to be released from further performance of the Contract, then upon notice by either Party to the other Party of such event or circumstance:

- (a) the Parties shall be discharged from further performance, without prejudice to the rights of either Party in respect of any previous breach of the Contract, and
- (b) the sum payable by the Employer to the Contractor shall be the same as would have been payable under GC Clause 6.6 [Optional Termination, Payment and Release] if the Contract had been terminated under GC Clause 6.6.

7. Finishing the Contract

7.1 Completion

7.1.1 The Contractor shall request the Project Manager to issue a Certificate of Completion of the Works, and the Project Manager shall do so upon deciding that the whole of the Works is completed.

7.2 Taking Over

7.2.1 The Employer shall take over the Site and the Works within seven days of the Project Manager's issuing a certificate of Completion.

7.3 Final Account

7.3.1 The Contractor shall supply the Project Manager with a detailed account of the total amount that the Contractor considers payable under the Contract before the end of the Defects Liability Period. The Project Manager shall issue a Defects Liability Certificate and certify any final payment that is due to the Contractor within 56 days of receiving the Contractor's account if it is correct and complete. If it is not, the Project Manager shall issue within 56 days a schedule that states the scope of the corrections or additions that are necessary. If the Final Account is still unsatisfactory after it has been resubmitted, the Project Manager shall decide on the amount payable to the Contractor and issue a payment certificate.

7.4 Operating and Maintenance Manuals

7.4.1 If "as built" Drawings and/or operating and maintenance manuals are required, the Contractor shall supply them by the dates stated in the **PC**.

7.4.2 If the Contractor does not supply the Drawings and/or manuals by the dates stated in the **PC** pursuant to **GC** Clause 7.4.1, or they do not receive the Project Manager's approval, the Project Manager shall withhold the amount stated in the **PC** from payments due to the Contractor.

7.5 Termination

7.5.1 The Employer or the Contractor may terminate the Contract if the other party causes a fundamental breach of the Contract.

7.5.2 Fundamental breaches of Contract shall include, but shall not be limited to, the following:

- (a) the Contractor stops work for 28 days when no stoppage of work is shown on the current Programme and the stoppage has not been authorized by the Project Manager;
- (b) the Project Manager instructs the Contractor to delay the progress of the Works, and the instruction is not withdrawn within 28 days;
- (c) the Employer or the Contractor is made bankrupt or goes into liquidation other than for a reconstruction or amalgamation;

- (d) a payment certified by the Project Manager is not paid by the Employer to the Contractor within 84 days of the date of the Project Manager's certificate;
- (e) the Project Manager gives Notice that failure to correct a particular Defect is a fundamental breach of Contract and the Contractor fails to correct it within a reasonable period of time determined by the Project Manager;
- (f) the Contractor does not maintain a Security, which is required;
- (g) the Contractor has delayed the completion of the Works by the number of days for which the maximum amount of liquidated damages can be paid, as defined in the **PC**; or
- (h) if the Contractor, as determined by the Employer, based on reasonable evidence, has engaged in corrupt or fraudulent practices in competing for or in executing the Contract, pursuant to **GC** Clause 7.6 [Fraud and Corruption].

7.5.3 When either party to the Contract gives notice of a breach of Contract to the Project Manager for a cause other than those listed under **GC** Clause 7.5.2 above, the Project Manager shall decide whether the breach is fundamental or not.

7.5.4 Notwithstanding the above, the Employer may terminate the Contract for convenience.

7.5.5 If the Contract is terminated, the Contractor shall stop work immediately, make the Site safe and secure, and leave the Site as soon as reasonably possible.

7.6 Fraud and Corruption

7.6.1 If the Employer determines that the Contractor has engaged in corrupt, fraudulent, collusive, coercive or obstructive practices, in competing for or in executing the Contract, then the Employer may, after giving 14 days notice to the Contractor, terminate the Contractor's employment under the Contract and expel him from the Site, and the provisions of **GC** Clause 7.5 [Termination] shall apply as if such expulsion had been made under **GC** Clause 7.5.2.

7.6.2 Should any employee of the Contractor be determined to have engaged in corrupt, fraudulent, coercive or obstructive practice during the execution of the work then that employee shall be removed in accordance with **GC** Clause 1.16.2.

7.6.3 It is the Bank's policy to require that Borrowers (including beneficiaries of Bank Financing), as well as bidders, suppliers, and contractors, and their agents (whether declared or not), subcontractors, sub-consultants, service providers or suppliers, and any personnel thereof, observe the highest standard of ethics during the procurement and execution of Bank-financed contracts¹⁷. In pursuance of this policy, the Bank:

- (a) defines, for the purposes of this provision, the terms set forth below as follows:

¹⁷ In this context, any action to influence the procurement process or contract execution for undue advantage is improper.

- (i) “Corrupt Practice” is the offering, giving, receiving, or soliciting, directly or indirectly, of anything of value to influence improperly the actions of another party¹⁸;
- (ii) “Fraudulent Practice” is any act or omission, including a misrepresentation that knowingly or recklessly misleads, or attempts to mislead, a party¹⁹ to obtain financial or other benefit or to avoid an obligation;
- (iii) “Collusive Practice” is an arrangement between two or more parties²⁰, designed to achieve an improper purpose, including to influence improperly the actions of another party; and
- (iv) “Coercive Practice” is impairing or harming, or threatening to impair or harm, directly or indirectly, any party or the property of the party to influence improperly the actions of a party²¹;
- (v) “obstructive practice” is
 - (v.1) deliberately destroying, falsifying, altering, or concealing of evidence material to the investigation or making false statements to investigators in order to materially impede a Bank investigation into allegations of a corrupt, fraudulent, coercive or collusive practice; and/or threatening, harassing or intimidating any party to prevent it from disclosing its knowledge of matters relevant to the investigation or from pursuing the investigation, or
 - (v.2) acts intended to materially impede the exercise of the Bank’s inspection and audit rights provided for under clause 1.12 [Inspections and Audits by the Bank]
- (b) will reject a proposal for award if it determines that the bidder recommended for award or any of its personnel, or its agents, or its sub-consultants, sub-contractors, service providers, suppliers and/or their employees, has, directly or indirectly engaged in Corrupt, Fraudulent, Collusive, Coercive or Obstructive Practices in competing for the contract in question;
- (c) will declare misprocurement and cancel the portion of the Financing allocated to a contract if it determines at any time that representatives of the Borrower or of a recipient of any part of the proceeds of such Financing engaged in Corrupt, Fraudulent, Collusive, Coercive or Obstructive Practices during the procurement or the implementation of that contract, without the Borrower having taken timely and appropriate action satisfactory to the Bank to address such practices when

¹⁸ For the purpose of this sub-paragraph, “another party” refers to a public official acting in relation to the procurement process or contract execution. In this context, “public official” includes Bank staff and employees of other organizations taking or reviewing procurement decisions.

¹⁹ For the purpose of this sub-paragraph, “party” refers to a public official; the terms “benefit” and “obligation” relate to the procurement process or contract execution; and the “act or omission” is intended to influence the procurement process or contract execution.

²⁰ For the purpose of this sub-paragraph, “parties” refers to participants in the procurement process (including public officials) attempting either themselves, or through another person or entity not participating in the procurement or selection process, to simulate competition or to establish bid prices at artificial, non-competitive levels, or are privy to each other’s bid prices or other conditions.

²¹ For the purpose of this sub-paragraph, “party” refers to a participant in the procurement process or contract execution.

they occur, including by failing to inform the Bank in a timely manner at the time they knew of the practices;

- (d) will sanction a firm or individual, at any time, in accordance with the prevailing Bank's sanctions procedures²², including by publicly declaring such firm or individual ineligible either indefinitely or for a stated period of time, (i) to be awarded Bank-financed contracts and (ii) to be a nominated²³ sub-contractor, consultant, supplier, or service provider of an otherwise eligible firm being awarded a Bank-financed contract; and
- (e) will require that a clause be included in bidding documents and in contracts financed by the Bank, requiring bidders, suppliers and contractors and their sub-contractors, agents, personnel, consultants, service providers, or suppliers to permit the Bank to inspect all accounts and records and other documents relating to the submission of bids and contract performance and to have them audited by auditors appointed by the Bank.

7.7 Payment upon Termination

7.7.1 If the Contract is terminated because of a fundamental breach of Contract by the Contractor, the Project Manager shall issue a certificate for the value of the work done and Materials ordered less advance payments received up to the date of the issue of the certificate and less the percentage to apply to the value of the work not completed, as indicated in the **PC**. Additional Liquidated Damages shall not apply. If the total amount due to the Employer exceeds any payment due to the Contractor, the difference shall be a debt payable to the Employer.

7.7.2 If the Contract is terminated for the Employer's convenience or because of a fundamental breach of Contract by the Employer, the Project Manager shall issue a certificate for the value of the work done, Materials ordered, the reasonable cost of removal of Equipment, repatriation of the Contractor's personnel employed solely on the Works, and the Contractor's costs of protecting and securing the Works, and less advance payments received up to the date of the certificate.

7.8 Property

²² A firm or an individual may be declared ineligible to be awarded a Bank financed contract: (i) upon completion of the Bank's sanctions proceedings as per its sanctions procedures, including, inter alia, cross-debarment as agreed with other International Financial Institutions, including Multilateral Development Banks, or otherwise decided by the Bank; and through the application of the Proposal for the Implementation of a Sanctions Process within the African Development Bank Group; and (ii) as a result of temporary suspension or early temporary suspension in connection with an on-going sanction proceeding. See footnote 18 and paragraph 9 of Appendix I of the Rules and Procedures for Procurement of Goods and Works.

²³ A nominated sub-contractor, consultant, manufacturer or supplier, or service provider (different names are used depending on the particular bidding documents) is one which has either been: (i) included by the bidder in its pre-qualification application or bid because it brings specific and critical experience and know-how that allow the bidder to meet the qualification requirement for the particular bid; or (ii) appointed by the Borrower. "

7.8.1 All Materials on the Site, Plant, Equipment, Temporary Works, and Works shall be deemed to be the property of the Employer if the Contract is terminated because of the Contractor's default.

7.9 Release from Performance

7.9.1 If the Contract is frustrated by the outbreak of war or by any other event entirely outside the control of either the Employer or the Contractor, the Project Manager shall certify that the Contract has been frustrated. The Contractor shall make the Site safe and stop work as quickly as possible after receiving this certificate and shall be paid for all work carried out before receiving it and for any work carried out afterwards to which a commitment was made.

7.10 Suspension of Bank Financing

7.10.1 In the event that the Bank suspends the Financing to the Employer, from which part of the payments to the Contractor are being made:

- (a) The Employer is obligated to notify the Contractor of such suspension within 7 days of having received the Bank's suspension notice.
- (b) If the Contractor has not received sums due it within the 28 days for payment provided for in GC Clause 4.6.1, the Contractor may immediately issue a 14-day termination notice.

7.11 Eligibility²⁴

7.11.1 The Contractor shall have the nationality from an eligible country of the Bank in accordance with the Bank's **Rules and Procedures for Procurement of Goods and Works**, as listed in Section V, Eligible Countries. The Contractor shall be deemed to have the nationality of a country if the Contractor is a citizen or is constituted, or incorporated, and operates in conformity with the provisions of the laws of that country. This criterion shall also apply to the determination of the nationality of proposed subcontractors or suppliers for any part of the Contract including related services.

7.11.2 The materials, equipment and services to be supplied under the Contract shall have their origin in eligible source countries and all expenditures under the Contract will be limited to such materials, equipment, and services. At the Employer's request, the Contractor may be required to provide evidence of the origin of materials, equipment and services.

7.11.3 For purposes of GC Clause 7.11.1, "origin" means the place where the materials and equipment are mined, grown, produced or manufactured, and from which the services are provided. Materials and equipment are produced when, through manufacturing, processing, or substantial or major assembling of components, a commercially recognized product results that differs substantially in its basic characteristics or in purpose or utility from its components.

²⁴ For the purposes of Eligibility, the provisions of the Bank's **Rules and Procedures for Procurement of Goods and Works** have been presented in detail at Section V, Eligible Countries.

Section VIII. Particular Conditions

1. General Provisions	
GC 1.1.2.2	The Employer is: Principal Secretary, State Department for Crop Development, Ministry of Agriculture and Livestock Development
GC 1.1 .2.4	The Project Manager is: Project Engineer SIVAP Hill Plaza 9th Floor
GC 1.1.2.6	The Bank is: Africa Development Fund
GC 1.1.2.7	The Borrower is: Republic of Kenya
GC 1.1.3.2	The Commencement Date shall be: <i>not later than 14 days after site handing over</i>
GC 1.1.3.3	The Completion Date for the whole of the Works shall be: four (4) months after commencement of works.
GC 1.1.5.6	If Sections are to be used: N/A
GC 1.1.5.8	<p>The contract works include: Description of the works</p> <p style="text-align: center;">The contract works include:</p> <ul style="list-style-type: none"> • Borehole drilling • Testing pumping • Supply and installation of solar panels and pump • Supply and Installation of a 10,000 litre Roto tank or an equally approved plastic tank • Fencing of borehole compound • Construction of a water Kiosk with slab for installing water tank. <p>Note: All the above works should be as per the attached drawings and Bills of quantities.</p>
GC 1.1.6.6	<p>LOCATION OF THE SITE</p> <p>The site is situated in Kiseuni village, Masinga Central Sub County in Machakos County</p>
GC 1.2.3	Sectional Completions shall not be applicable.
GC 1.2.4(i)	The following documents also form part of the Contract:

	<ul style="list-style-type: none"> a) the Letter of Acceptance b) the Bid c) All Addenda, if any d) the Particular Conditions e) the General Conditions f) the Specification g) the Drawings; and h) the completed Schedules,
GC 1.3.1(a)	The Electronic Transmission System is: None
GC 1.3.1(b)	<p>The Employer's address for the purpose of communications is: Project Coordinator, Attention : Project coordinator Small Scale Irrigation and Value Addition Project State Department for Crop Development Ministry of Agriculture and Livestock Development Hill Plaza, 9th Floor P.O. Box 30028, 00100 Nairobi Email: npcsivap@gmail.com</p> <p>The Contractor's address for the purpose of communications is: [state full address, telephone, fax and e-mail</p>
GC 1.4.1	<p>The governing law is that of: Republic of Kenya</p> <p>The ruling language is: English</p> <p>The language for communications is: English</p>
GC 1.6.1	The Parties shall enter into contract within 28 days after the Contractor receives the Letter of Acceptance.
GC 1.10.2(a)	Permits, approvals and/or licenses, or public service undertakings to be acquired by the Employer: as in the specifications
GC 1.10.2(b)	Permits, approvals and/or licenses, or public service undertakings to be acquired by the Contractor: as in the specifications
GC 1.11.1	The individuals or firms in a joint venture, consortium or association shall be jointly and severally liable.
GC 1.17.1	Schedule of Other Contractors: None
GC 1.21.1	<p>The minimum insurance amounts and deductibles shall be:</p> <ul style="list-style-type: none"> (a) for loss or damage to the Works, Plant and Materials: KES 100,000.00 (b) for loss or damage to Equipment: KES 50,000.00

	(c) for loss or damage to property (except the Works, Plant, Materials, and Equipment) in connection with Contract: KES 50,000.00 (d) for personal injury or death: (i) of the Contractor's employees: KES 50,000.00 (ii) of other people: KES 100,000.00
GC 1.22.1	Site Investigation Reports shall include: design report, drawings and any other investigation as may be required by the engineer
GC 1.28.1	The Site Possession Date(s) shall be <i>not later than 14 days after contract signing</i>
GC 1.31.1 & 1.31.2	Appointing Authority for the Adjudicator: Chartered Institute of Arbitrators, Kenya P.O. Box 50163 - 00200 Nairobi, Kenya Email Address: info@ciarbkenya.org
GC 1.32.3	Hourly rate and types of reimbursable expenses to be paid to the Adjudicator: as per as body's policy
GC 1.32.4	Institution whose arbitration procedures shall be used: Chartered Institute of Arbitrators, Kenya The place of arbitration shall be: Nairobi, Kenya]
2. Time Control	
GC 2.1.1	The Contractor shall submit for approval a Programme for the Works within 7 days from the date of the Letter of Acceptance.
GC 2.1.3	The period between Programme updates is 30 days. The amount to be withheld for late submission of an updated Programme is: 10% of amount due in next certificate
3. Quality Control	
GC 3.3.1	The Defects Liability Period is: 30 days.
4. Cost Control	
GC 4.9.1	The currency of the Employer's country is: Kenya Shillings
GC 4.10.1	The Contract " shall not " be subject to price adjustment, in accordance with GC Clause 4.10.1, and the following information regarding coefficients
GC 4.11.1	The proportion of payments retained is: 10%

GC 4.12.1	The Liquidated Damages for the whole of the Works are 0.05 of the final Contract Price, per day. The maximum amount of Liquidated Damages for the whole of the Works is 5% of the final Contract Price.
GC 4.13.1	The Bonus for the whole of the Works is 0% of the final Contract Price, per day. The maximum amount of Bonus for the whole of the Works is 0% of the final Contract Price.
GC 4.14.1	The Advance Payment shall be: 10% of the contract sum and shall be paid to the Contractor no later than: 60 days
GC 4.15.1	The Performance Security amount is: 10% of contract sum in the form of: (a) Bank Guarantee: [A Bank Guarantee shall be unconditional (on demand) (see Section IX, Contract Forms).
7. Finishing the Contract	
GC 7.4.1	The date by which operating and maintenance manuals are required shall be: date of completion of works The date by which “as built” drawings are required shall be: date of completion of works
GC 7.4.2	The amount to be withheld for failing to produce “as built” drawings and/or operating and maintenance manuals by the date required in GC Clause 7.7.1 shall be: KES 100,000.00
GC 7.5.2 (g)	The maximum number of days is: 30 days
GC 7.7.1	The percentage to apply to the value of the work not completed, representing the Employer’s additional cost for completing the Works, shall be: 100% of work not done

Section IX. Contract Forms

This Section contains Contract Forms which, once completed, will constitute part of the Contract. The forms for Contract Agreement, Performance Security and Advance Payment Security, when required, shall only be completed by the successful Bidder, after contract award

Table of Forms

<u>Letter of Acceptance</u>	224
<u>Contract Agreement</u>	225
<u>Option I: Performance Security</u>	227
<u>Option II: Performance Bond</u>	229
<u>Advance Payment Security</u>	231
<u>Retention Money Security</u>	233

Letter of Acceptance

[on letterhead paper of the Employer]

..... **[date]**.

To: **[name and address of the Contractor]**

Subject: **[Notification of Award Contract No]**.....

This is to notify you that your Bid dated **[Insert date]** for execution of the
.. **[insert name of the contract and identification number]** for the amount of . .
. **[insert amount (s) in figures and words and name(s) of currency(ies)]**, as corrected
and modified in accordance with the Instructions to Bidders is hereby accepted by us.

You are requested to furnish the Performance Security in the amount of **[insert amount (s) in figures and words and name(s) of currency(ies)]** within 28 days²⁵ in accordance with the Conditions of Contract, using for that purpose the Performance Security Form included in Section IX (Contract Forms) of the Bidding Document.

We accept the appointment of **[Employer to insert full name and address of alternative appointee proposed by Bidder in Letter of Bid]** as the Adjudicator. / We do not accept the appointment of **[Employer to insert full name and address of alternative appointee proposed by Bidder in Letter of Bid]** as the Adjudicator. And, consequently, the provisions of GC Clause 1.31 shall apply.²⁶

Authorized Signature:

Name and Title of Signatory:

Name of Agency:

Attachment: Contract Agreement

²⁵ Or, the alternative deadline stipulated in the **Particular Conditions**.

²⁶ Use one of the two options as appropriate.

Contract Agreement

THIS CONTRACT AGREEMENT is made on the [**insert: number**] day of [**insert: month**], [**insert: year**].

BETWEEN

(1) [**insert complete name of the Employer**], a [**insert description of type of legal entity, for example, an agency of the Ministry of**] of the Government of { **insert name of Country of the Employer** }, or corporation incorporated under the laws of { **insert name of Country of the Employer** } and having its principal place of business at [**insert address of the Employer**] (hereinafter called “the Employer”),

and

(2) [**insert name of the Contractor**], a corporation incorporated under the laws of [**insert: country of Contractor**] and having its principal place of business at [**insert: address of Contractor**] (hereinafter called “the Contractor”).

WHEREAS the Employer invited bids for the Works, described as [**insert brief description of the Works**] and has accepted a Bid by the Contractor for the execution and completion of these Works and the remedying of any defects therein, and the Employer agrees to pay the Contractor the Contract Price or such other sum as may become payable under the provisions of the Contract at the times and in the manner prescribed by the Contract.

The Employer and the Contractor agree as follows:

1. In this Agreement words and expressions shall have the same meanings as are respectively assigned to them in the Contract documents referred to.

2. The following documents shall be deemed to form and be read and construed as part of this Agreement. This Agreement shall prevail over all other Contract documents.

- (a) the Letter of Acceptance
- (b) the Bid
- (c) the Addenda Nos [**insert addenda numbers if any**].
- (d) the Particular Conditions
- (e) the General Conditions
- (f) the Specification
- (g) the Drawings; and
- (h) the completed Schedules,

3. In consideration of the payments to be made by the Employer to the Contractor as indicated in this Agreement, the Contractor hereby covenants with the Employer to execute

the Works and to remedy defects therein in conformity in all respects with the provisions of the Contract.

4. The Employer hereby covenants to pay the Contractor in consideration of the execution and completion of the Works and the remedying of defects therein, the Contract Price or such other sum as may become payable under the provisions of the Contract at the times and in the manner prescribed by the Contract.

Agreement to be executed in accordance with the laws of **[insert name of the borrowing country]** on the day, month and year indicated above.

Signed by:

Signed by:

For and on behalf of the Employer

for and on behalf the Contractor

In the presence of:

in the presence of:

Witness, Name, Signature, Address, Date

Witness, Name, Signature, Address, Date

Option I: Performance Security

[The bank, as requested by the successful Bidder, shall fill in this form in accordance with the instructions indicated]

Date: **[insert date (e.g., day, month, and year)]**

Bidding Process Reference: **[insert no. and title of bidding process]**

Bank's Branch or Office: **[insert complete name of Guarantor]**

Beneficiary: **[insert complete name of Employer]**

PERFORMANCE GUARANTEE No.: **[insert Performance Guarantee number]**

We have been informed that **[insert complete name of the Contractor]** (hereinafter called "the Contractor") has entered into Contract No. **[insert number]** dated **[insert day and month]**, **[insert year]** with you, for the execution and completion of **[insert description of the Works]** and the remedying of any defects therein (hereinafter called "the Contract").

Furthermore, we understand that, according to the conditions of the Contract, a Performance Guarantee is required.

At the request of the Employer, we hereby irrevocably undertake to pay you any sum(s) not exceeding **[insert amount(s)²⁷ in figures and words]** such sum being payable in the types and proportions of currencies in which the Contract Price is payable, upon receipt by us of your first demand in writing declaring the Contractor to be in default under the Contract, without cavil or argument, or your needing to prove or to show grounds or reasons for your demand or the sum specified therein.

²⁷ The Bank shall insert the amount(s) specified in the **PC** and denominated, as specified in the **PC**, either in the currency(ies) of the Contract or a freely convertible currency acceptable to the Employer.

This Guarantee shall expire no later than the **[insert number]** day of **[insert month]**, **[insert year]**,²⁸ and any demand for payment under it must be received by us at this office on or before that date. This guarantee is subject to the Uniform Rules for Demand Guarantees, ICC Publication No. 458, except that subparagraph (ii) of Sub-article 20(a) is hereby excluded.

[signatures of authorized representatives of the bank]

²⁸ Insert the date twenty-eight days after the expected completion date. The Employer should note that in the event of an extension of the time for completion of the Contract, the Employer would need to request an extension of this guarantee from the Guarantor. Such request must be in writing and must be made prior to the expiration date established in the guarantee. In preparing this guarantee, the Employer might consider adding the following text to the form, at the end of the penultimate paragraph: "The Guarantor agrees to a one-time extension of this guarantee for a period not to exceed [six months][one year], in response to the Employer's written request for such extension, such request to be presented to the Guarantor before the expiry of the guarantee."

Option II: Performance Bond

By this Bond _____ as Principal (hereinafter called “the Contractor”) and _____] as Surety (hereinafter called “the Surety”), are held and firmly bound unto _____] as Obligee (hereinafter called “the Employer”) in the amount of _____, for the payment of which sum well and truly to be made in the types and proportions of currencies in which the Contract Price is payable, the Contractor and the Surety bind themselves, their heirs, executors, administrators, successors and assigns, jointly and severally, firmly by these presents.

WHEREAS the Contractor has entered into a written Agreement with the Employer dated the _____ day of _____, 20 ____, for _____ in accordance with the documents, plans, specifications, and amendments thereto, which to the extent herein provided for, are by reference made part hereof and are hereinafter referred to as the Contract.

NOW, THEREFORE, the Condition of this Obligation is such that, if the Contractor shall promptly and faithfully perform the said Contract (including any amendments thereto), then this obligation shall be null and void; otherwise, it shall remain in full force and effect. Whenever the Contractor shall be, and declared by the Employer to be, in default under the Contract, the Employer having performed the Employer’s obligations thereunder, the Surety may promptly remedy the default, or shall promptly:

- (1) complete the Contract in accordance with its terms and conditions; or
- (2) obtain a Bid or bids from qualified Bidders for submission to the Employer for completing the Contract in accordance with its terms and conditions, and upon determination by the Employer and the Surety of the lowest responsive Bidder, arrange for a Contract between such Bidder and Employer and make available as work progresses (even though there should be a default or a succession of defaults under the Contract or Contracts of completion arranged under this paragraph) sufficient funds to pay the cost of completion less the Balance of the Contract Price; but not exceeding, including other costs and damages for which the Surety may be liable hereunder, the amount set forth in the first paragraph hereof. The term “Balance of the Contract Price,” as used in this paragraph, shall mean the total amount payable by Employer to Contractor under the Contract, less the amount properly paid by Employer to Contractor; or
- (3) pay the Employer the amount required by Employer to complete the Contract in accordance with its terms and conditions up to a total not exceeding the amount of this Bond.

The Surety shall not be liable for a greater sum than the specified penalty of this Bond.

Any suit under this Bond must be instituted before the expiration of one year from the date of the issuing of the Taking-Over Certificate.

No right of action shall accrue on this Bond to or for the use of any person or corporation other than the Employer named herein or the heirs, executors, administrators, successors, and assigns of the Employer.

In testimony whereof, the Contractor has hereunto set his hand and affixed his seal, and the Surety has caused these presents to be sealed with his corporate seal duly attested by the signature of his legal representative, this _____ day of _____ 20 ____.

Advance Payment Security

[The bank, as requested by the successful Bidder, shall fill in this form in accordance with the instructions indicated.]

Date: **[insert date (e.g., day, month, and year) of Bid Submission]**

Bidding Process Reference: **[insert number and title of bidding process]**

[bank's letterhead]

Beneficiary: [insert legal name and address of Employer]

ADVANCE PAYMENT GUARANTEE No.: [insert Advance Payment Guarantee no.]

We have been informed that **[insert name of the Contractor]**. (hereinafter called "the Contractor") has entered into Contract No. **[insert reference number of the Contract]**. dated **[insert day and month]**, **[insert year]**. with you, for the execution of **[insert name of contract and brief description of Works]** (hereinafter called "the Contract").

Furthermore, we understand that, according to the Conditions of the Contract, an advance payment in the sum . . . **[insert currency and amount in figures]**²⁹. . . (. **[insert currency and amount in words]**. . .) is to be made against an advance payment guarantee.

At the request of the Employer, we **[insert name of the Bank]**. hereby irrevocably undertake to pay you any sum or sums not exceeding in total an amount of **[insert currency and amount in figures]***. (. **[insert currency and amount in words]**.) upon receipt by us of your first demand in writing accompanied by a written statement stating that the Contractor is in breach of its obligation under the Contract because the Contractor used the advance payment for purposes other than performing his obligations under the Contract or the costs of mobilization in respect of the Works.

It is a condition for any claim and payment under this guarantee to be made that the advance payment referred to above must have been received by the Contractor on its account number **[insert Contractor's account number]**. at **[insert name and address of the Bank]**.

²⁹ The Guarantor shall insert an amount representing the amount of the advance payment denominated either in the currency(ies) of the advance payment as specified in the Contract, or in a freely convertible currency acceptable to the Employer

The maximum amount of this guarantee shall be progressively reduced by the amount of the advance payment repaid by the Contractor as indicated in copies of interim statements or payment certificates which shall be presented to us. This guarantee shall expire, at the latest, upon our receipt of a copy of the interim payment certificate indicating that eighty (80) percent of the Contract Price has been certified for payment, or on the . . . day of³⁰, whichever is earlier. Consequently, any demand for payment under this guarantee must be received by us at this office on or before that date.

This guarantee is subject to the Uniform Rules for Demand Guarantees, ICC Publication No. 458, except that subparagraph (ii) of Sub-article 20(a) is hereby excluded..

. [Seal of Bank and Signature(s)].

Note –

All italicized text (including footnotes) is for guidance on how to prepare this demand guarantee and shall be deleted from the final document.

³⁰ Insert the expected expiration date of the Time for Completion. The Employer should note that in the event of an extension of the time for completion of the Contract, the Employer would need to request an extension of this guarantee from the Guarantor. Such request must be in writing and must be made prior to the expiration date established in the guarantee. In preparing this guarantee, the Employer might consider adding the following text to the form, at the end of the penultimate paragraph: “The Guarantor agrees to a one-time extension of this guarantee for a period not to exceed [insert number of months], in response to the Employer’s written request for such extension, such request to be presented to the Guarantor before the expiry of the guarantee.”]

Retention Money Security

Demand Guarantee

_____ [insert Bank's Name, and Address of Issuing Branch or Office]

Beneficiary: _____ [insert Name and Address of Employer]

Date: _____ [insert date (e.g., day, month, and year)]

RETENTION MONEY GUARANTEE No.: [insert Retention Money Guarantee no.]

We have been informed that _____ [insert name of Contractor] (hereinafter called "the Contractor") has entered into Contract No. _____ [insert reference number of contract] dated _____ [insert date] with you, for the execution of _____ [insert name of contract and brief description of Works] (hereinafter called "the Contract").

Furthermore, we understand that, according to the conditions of the Contract, when the Taking-Over Certificate has been issued for the Works and the first half of the Retention Money has been certified for payment, payment of **[insert either "the second half of the Retention Money", or, if the amount guaranteed under the Performance Guarantee, when the Taking-Over Certificate is issued, is less than half of the Retention Money, "the difference between half of the Retention Money and the amount guaranteed under the Performance Security"]** is to be made against a Retention Money guarantee.

At the request of the Employer, we _____ [insert name of Bank] hereby irrevocably undertake to pay you any sum or sums not exceeding in total an amount of _____ [insert amount in figures] () [insert amount in words]¹ upon receipt by us of your first demand in writing accompanied by a written statement stating that the Contractor is in breach of its obligation under the Contract because the Contractor used the advance payment for purposes other than the costs of mobilization in respect of the Works.

¹ *The Guarantor shall insert an amount representing the amount of the second half of the Retention Money or, if the amount guaranteed under the Performance Guarantee when the Taking-Over Certificate is issued is less than half of the Retention Money, the difference between half of the Retention Money and the amount guaranteed under the Performance Security and denominated either in the currency(ies) of the second half of the Retention Money as specified in the Contract, or in a freely convertible currency acceptable to the Employer.*

It is a condition for any claim and payment under this guarantee to be made that the payment of the second half of the Retention Money referred to above must have been received by the Contractor on its account number _____ **[insert Contractor's account number]** at _____ **[insert name and address of the Bank]**.

This guarantee shall expire, at the latest, 21 days after the date when the Employer has received a copy of the Performance Certificate issued by the Project Manager. Consequently, any demand for payment under this guarantee must be received by us at this office on or before that date.

This guarantee is subject to the Uniform Rules for Demand Guarantees, ICC Publication No. 458.

[signature(s)]

Note: All italicized text (including footnotes) is for use in preparing this form and shall be deleted from the final product.